

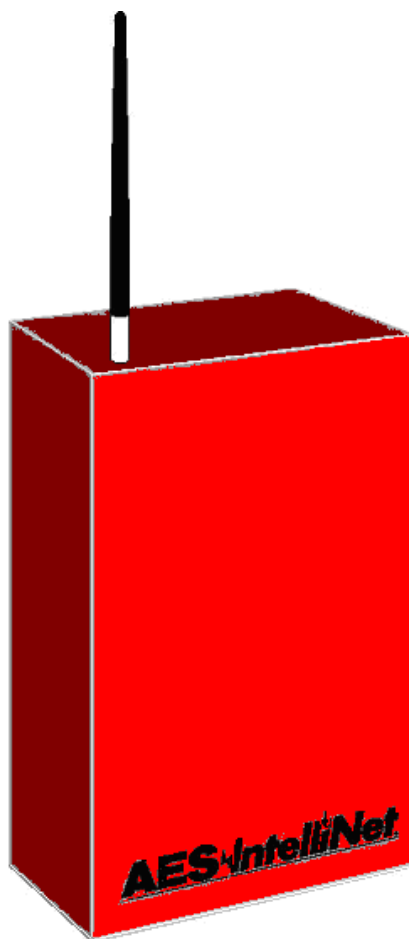

7744F

RF Subscriber Unit

Installation and Operation Manual



**SECURITY
SIGNALING**



LISTED

AES Corporation
285 Newbury Street
Peabody, MA 01960-1315 USA
Tel (978) 535-7310 • Fax (978) 535-7313
www.aes-corp.com
Copyright 2014 -2016 All Rights Reserved

P/N 40-7744
Rev 6
August 30, 2016

NOTICE TO USERS, INSTALLERS, AUTHORITIES HAVING JURISDICTION, AND OTHER INVOLVED PARTIES

This product incorporates field-programmable software. In order for the product to comply with the requirements in the Standard for Control Units and Accessories for Fire Alarm Systems, UL 864, certain programming features or options must be limited to specific values or not used at all as indicated below.

Group	Program Feature or Option	Permitted in UL 864 (Y/N)	Possible functional settings	Settings permitted in UL 864
Timing Parameters				
	AC Fail Report Delay	Y	0-60 Min or Random	R (Random) or 0-60 (Minutes)
	Reporting Delay	Y	0 – 80 Seconds	10 – 20 Seconds
Zone Programming				
	Fire/Trouble PKT	Y	Y or N	Y
	Zone Programming	Y	S, F or B	If zone is in use F If not in use B
	Restoral	Y	X or R	R
Set Modes				
	Enable Repeating	Y	Y or N	Y
	Suppress AC Fail	N	Y or N	N
By Remote programming only				
	Acknowledge Delay *	Y	60 – 330 Seconds	Not greater than 60 Seconds

* Acknowledge delay is used in detecting the existence of a functional antenna and therefore affects antenna cut detection.

Note: UL and NFPA do not allow remote programming of an installed 7744F unless an authorized person is present at the unit to temporarily enable this capability. Selecting “Y” for Fire/Trouble PKT in Zone Programming function disables remote programming. Entering one of the programming modes accessed with a directly attached programmer by <Ctrl> <F1>, <Ctrl> <F2> or <Ctrl> <F3> enables remote programming for 10 minutes.

TABLE OF CONTENTS

1 AES 7744F RF Subscriber Unit..... 5

1.1 Description 6

1.2 New features 6

1.3 Easy Installation..... 6

1.4 Power Requirements 6

 1.4.1 Battery Calculations..... 7

1.5 RF Module (Transceiver)..... 7

1.6 Optional Accessories 7

1.7 Safety Considerations 7

1.8 Technical Specifications 9

1.9 UHF Antenna Options: 10

1.10 Coaxial Cable Options 10

1.11 Coaxial Cable and Antenna Installation Tips 11

2 Commercial Fire and Burglary Installation Notes 12

2.1 Power Requirements: 16.5 VAC, 40VA/45VA;..... 13

2.2 Backup Battery requirement, Commercial Fire 13

2.3 UL 681: 13

2.4 UL 1610/365: 13

2.5 7744F EOL Inputs / Zones:..... 13

3 Installation 14

3.1 Overview 14

3.2 Physical Installation 14

3.3 Antenna Grounding and Surge Protector 16

3.4 Wiring - General 18

3.5 Wiring – Antenna Cut / Trouble Output (J4)..... 19

3.6 Wiring - Zone Inputs..... 22

3.7 Power Up 25

3.8 SELF-TEST / STATUS ERROR CODES..... 26

3.9 Status (LED) Indicators 27

3.10 ALM LED Blink Pattern Chart..... 27

4 Programming..... 28

4.1 Remote Programming Limitations (Enable/Disable)..... 28

4.2 Program ID# and System Cipher Code..... 29

4.3 Timing Parameters (Check-In Time and Reporting Delays) 29

4.4 Zone Programming 31

4.5 Set Modes – Enable Repeating and Suppress AC Fail 33

4.6 Reset RAM..... 33

4.7 Initializing the Subscriber Unit..... 34

4.8 Local Status Check 35

4.9 Monitor and Key Transmitter Functions..... 36

4.10 KEY TRANSMITTER 36

4.11 Display Zone Status 37

4.12 Display Routing Table 37

4.13 Text Messages..... 38

4.14 Handheld Programmer – Quick Command Guide..... 39

4.15 Reconnect Cables after Programming 39

4.16	Programming the Subscriber Unit from a PC	39
5	Testing.....	40
5.1	Installation Site Checks.....	40
5.2	Acknowledge delays	40
6	Maintenance, Compliance, Warranty and Repair.....	41
6.1	Troubleshooting	41
6.2	Parts List	41
6.3	Contact Information	41
6.4	Warranty and Service Procedure	42

1 AES 7744F RF Subscriber Unit

AES 7744F Subscriber Unit / RF Signaling Device

WARNING:
It is unlawful to operate this equipment without a valid radio station license.
If the antenna or cables connected to this equipment come in contact with electrical power lines, DEATH or SERIOUS INJURY may result.
Never install the antenna where people may come in contact with it as SERIOUS INJURY may result.
Test this system periodically for proper operation. AES assumes no responsibility for this equipment's failure to operate. AES's sole responsibility is to repair or replace any AES device found to be defective during the warranty period.

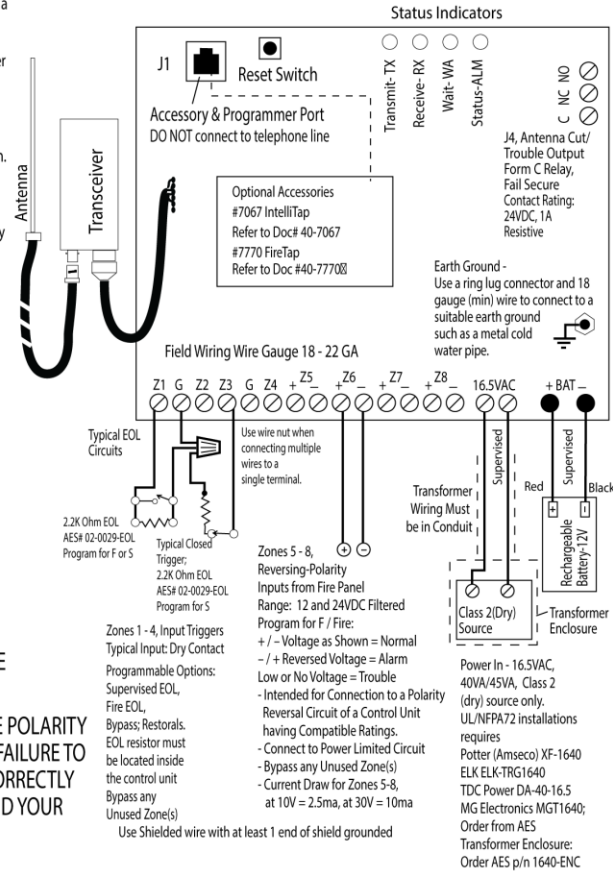

• **WARNING: TO PREVENT RISK OF SHOCK, DE-ENERGIZE THIS DEVICE PRIOR TO SERVICING.**

• **CAUTION: DO NOT REVERSE THE POLARITY OF THE BATTERY CONNECTIONS. FAILURE TO CONNECT THE BATTERY LEADS CORRECTLY MAY RESULT IN DAMAGE AND VOID YOUR WARRANTY.**

- **TYPES OF FIRE SIGNALING SERVICE:**
Remote Station / Central Station
- Also Refer to NFPA72 for Installation Requirements
- **SIGNALING TYPE - RF TYPE 6**
- Not Suitable for Remote Station Protected Premises Service where Separate Transmission Circuits are Required for Fire, Supervisory (when applicable) and Trouble Signals
- **APPLICATION and SIGNALING FUNCTION:**
Mercantile Burglar Alarm
Commercial Central Station / Police Connect
Standard Line Security
- Radio Test for Signal Strength, Ambient Noise Level
After installation, observe "RX" Receive Light:
• If RX Light is off or flashing intermittently, unit is OK.
• If RX Light is ON steady for more than 20 seconds, do not use this unit. Contact Factory.
- **Field Programmable Parameters:**
Refer to Manual 40-7744, Rev 6, August 30, 2016

- **Model Number 7744F**
- **Electrical Input Rating:** 16.5 V, 60 Hz, 40 VA, Transformer (Connect With min 18-22 ga Wire)
- **DC Current Draw:**
Subscriber Only: 150mA standby, 1.2A transmit
Subscriber & Tap: 210mA standby, 1.3A transmit
- Onboard Battery Fuse: Self Resetting / Not User Serviceable
- Onboard Transceiver Fuse: Self-Resetting / Not User Serviceable
- **ALL CIRCUITS EXCEPT BATTERY LEADS ARE POWER LIMITED**
- **ALL CIRCUITS ARE SUPERVISED**
- **Rechargeable Battery Req.:**
12V, 7.5AH - 10AH, Lead Acid Gel Type
Replace Battery Every 3 Years or Less
Standby Time 24 Hours
- Low Battery Condition, AC Failure and Charger Trouble are reported to the central station
- **INDOOR - DRY LOCATIONS**
- **REFER TO INSTALLATION MANUAL 40-7744, Rev 6, August 30, 2016**

SOFTWARE REV:	FIRMWARE REV:
SERIAL NUMBER:	DATE OF MFR:

For Service Call:

Install Date: _____

AES IntelliNet
CORPORATION | For Alarm Monitoring
285 Newbury Street Peabody, MA 01960 USA www.aes-intellinet.com



Label p/n 40-7744-L1, REV 11

Enclosure Cover Label

1.1 Description

The 7744F Subscriber Unit is an AES-IntelliNet RF Communicator, which is typically used to link an alarm panel to an alarm monitoring central station. This series unit is UL Listed and NFPA compliant for commercial fire alarm monitoring as well as Burglar alarm installations. This unit has 8 wired inputs. Four inputs are of the end of line resistor (EOL) type and four are designed for connection to reversing voltage outputs available in some Fire alarm panels. For those that do not need or want the 4 reversing voltage inputs, there is another model – 7788F – that has eight inputs of the EOL type without the 4 reversing voltage inputs.

1.2 New features

This section is included for those customers familiar with other AES IntelliNet UL Subscriber products. Listed below are the new features incorporated into the unit.

- Fail Secure Relay on board for Acknowledge Delay / Antenna Cut / Low Battery / Charger Fail output. Formally was a Fail Safe open collector output and only for Antenna cut / Acknowledge Delay.
- Separate power no longer required for the Zone Input Module as required on the 7750-F-4X4 and 7750-F-8.
- AC Failure Random Reporting Delay. AC failure/restore messages are generated when they exist continuously for 100 minutes. The actual transmission of the generated message is delayed a random number of minutes between 0 and 60. The delay is set at the time the event is generated. This setting has no effect on the time of detection of the failure. That is hardcoded at 100 minutes.
- Transceiver power PTC is added. It is installed in series with the power line to the transceiver disconnecting power if the transceiver draws too much current.
- Remote programming using software at the central station is disabled when Trouble Packets are enabled. This can temporarily be enabled using a directly attached programmer in the Programmer Jack. This is to comply with UL/NFPA requirements. Trouble Packets are enabled when “Y” is the response to the question “Fire/Fire Zones” in Zone Programming <Ctrl> + F3.

1.3 Easy Installation

The 7744F unit is housed in a rugged lockable steel box for long lasting protection and easy installation. The alarm panel’s alarm outputs are connected to the 7744F Unit. A supplied AES-IntelliNet tamper resistant 2.5 dB flexible antenna can be secured to the subscriber enclosure in the provided hole, or use a remotely installed antenna, purchased separately. Once powered and properly configured, the 7744F RF Subscriber self-enrolls into the AES-IntelliNet wireless network, receives signals from the alarm panel and transmits them via wireless mesh radio to the AES-IntelliNet central receiver.

1.4 Power Requirements

The steady state DC current draw is only 150mA (with optional accessories). The peak current draw of 1.2A (1.3A with optional accessories) for RF power output levels of 2W, is only for a very short transmit duration of less than 1/3 second.

1.4.1 Battery Calculations

Description	Current	Battery Size Required
7744F	See 7744F Installation and Operation Manual	7.5 Ah
7744F + 7794	See 7744F & 7794 Installation and Operation Manuals	7.5 Ah
7744F + 7794 + 7762 + 7740	See 7744F, 7794 & 7762 Installation and Operation Manuals. For 7740 refer to Sec. 3.5 – Fig. 4A and Fig. 4B in this manual.	12 Ah
7744F + 7762 + 7740	See 7744F & 7762 Installation and Operation Manuals. For 7740 refer to Sec. 3.5 – Fig. 4A and Fig. 4B in this manual.	12 Ah

1.5 RF Module (Transceiver)

Each 7744F Unit includes an RF Module known as a transceiver along with a standard tamper resistant 2.5 dB flexible omni-directional antenna. The standard antenna supplied is for the frequency range of 450-480MHz. Contact AES for additional information on available Models for use with other Non-UL frequencies and antennas.

[See UHF Antenna Options in Section 1.9](#)

1.6 Optional Accessories

7041 – Hand Held Subscriber Programmer

7043E – Programming Cable for PC or laptop to E Family subscribers with Modular programming Jack and 7794 IntelliPro Fire

7794 – **AES IntelliPro Fire**, Dialer Capture Module

7067 – **AES IntelliTap II**, Dialer Capture Module

7770 – **AES FireTap** Serial Data Module

7762 – **AES** Hardware Supervisor

1.7 Safety Considerations

- ◆ All equipment must be installed in accordance with any and all applicable National Electric Code, NFPA 70, National Fire Code NFPA 72, Canadian Electrical code, local building codes and any other applicable codes, laws or regulations.
- ◆ It is unlawful to operate this equipment in the USA without a valid FCC radio station license. It is unlawful to operate this equipment in Canada without a valid Industry Canada license. Other countries most likely require licensing through appropriate authorities as well.
- ◆ Be certain to properly ground the antenna, 7744F enclosure and any surge protection devices to help dissipate surges away from the equipment and

personnel. The grounding of the antenna and surge protector is for your safety and the safety of your equipment and should not be neglected.

- ◆ If the antenna or cables connected to this equipment come in contact with electrical power lines, DEATH or SERIOUS INJURY may result.
- ◆ Test this system periodically for proper operation. AES assumes no responsibility for this equipment's failure to operate. AES' sole responsibility is to repair or replace any AES device found to be defective during the warranty period.
- ◆ Exposure to extreme cold below 0°C or extreme hot above 50°C could damage any Gel battery used in the installation of this product. Extreme temperatures can also cause unexpected operation of the electronics.
- ◆ Exposure of the electronics to excessive water or moisture (such as a rain, shower, bath, pool, sauna, etc.) could cause damage and unexpected operation.
- ◆ Avoid dropping or other physical impact to the unit, which could damage the enclosure or internal components.

1.8 Technical Specifications

- ◆ SIZE: 13.25”h X 8.5”w X 4.3”d (34 cm X 21.5 cm X 11 cm) excluding antenna
- ◆ WEIGHT: 5.8 pounds (2.6 kilograms) Without Battery (Add 6 pounds with Battery)
- ◆ TRANSFORMER SECONDARY POWER INPUT: 16.5VAC, 40VA class 2 (dry) source only
- ◆ VOLTAGE: 12VDC nominal
- ◆ MAINS INPUT CURRENT: 150 mA standby; 1.2A transmit
- ◆ MAINS INPUT CURRENT with 7067/7770: 210 mA standby; 1.3 A transmit (2 Watt Transceiver)
- ◆ OPERATING TEMPERATURE RANGE: 0° to 49° C (32° to 120°F)
- ◆ STORAGE TEMPERATURE RANGE: -10° to 60° C (14° to 140°F)
- ◆ RELATIVE HUMIDITY RANGE: 0 to 93% RHC, Non Condensing
- ◆ BACK-UP BATTERY: 12V, 7.5AH – 12AH (24 Hour standby), 1.2A Max.
(Min), lead acid gel type; required for all installations
- ◆ BATTERY FUSE: Onboard self-resetting fuse. Not serviceable
- ◆ ALARM SIGNAL INPUTS: 8 Supervised individually programmable Zones:
4 EOL, Trouble & Restore
4 Reversing DC Voltage 12 or 24 Volts
- ◆ LOW BATTERY REPORTING: Below 11V. 22.5 Minute Test Cycle (approx)
- ◆ AC FAILURE REPORTING: AC Fail messages are queued for transmission to central station after approximately 100 continuous minutes without AC power. Transmission to central station is then delayed randomly between 0 to 60 minutes. Restore is similar with Restore message queued for transmission after approximately 100 continuous minutes with AC power restored. AC Fail/Restore messages will be sent between 100 and 160 minutes after the failure or restore occurs that remains for 100 minutes. See [Section 4.3 - Timing Parameters](#) for additional information and programming options.
- ◆ ANTENNA CUT / LOW BATTERY / CHARGER FAIL LOCAL REPORTING: Form C Fail Secure Relay contact. Engaged for normal operation. Disengages on Reset, Antenna Cut/Acknowledge Delay, total power loss condition, low battery or charger fail. Contact rating – 24VDC 1-Amp max, Not Supervised.
- ◆ RESET BUTTON: Located on the PCB.
- ◆ TRANSCEIVER:
 - Standard UHF Frequency Ranges (410-440MHz, 440-470MHz, 470-512MHz)
- ◆ TRANSCEIVER FUSE: 400 milliamp PTC, Not serviceable
- ◆ STANDARD RF OUTPUT POWER: 2 Watts
- ◆ Zone 5-8 Input Reversing Voltage: 12VDC and 24VDC Filtered, Self Powered
- ◆ Zone 5-8 Current Draw: at 12V = 1.54mA, at 24V = 3.2mA Connect to power limited circuits only. Supervised.
- ◆ Zones 1-4: dry contact supervised with 2.2K EOL resistor
- ◆ GROUND FAULT: A ground fault as tested by UL, is when an isolated ground terminal of a Supervised zone labeled “G” is less than 0.1 Ohm impedance to Earth Ground. A zone 10 Trouble is transmitted for this fault. The CID code generated at alarm automation for a Ground Fault is E370 C010.

1.9 UHF Antenna Options: (450-480 MHz; contact factory for other frequencies)

Antenna db	Construction	Usage	Length	P/N
2.5 db Case Top Flex Tamper Resistant ^(1 & 2)	Vinyl Clad	Indoor	11 in	7214
3 db Stealth (Not shown below) ⁽³⁾	Vinyl Clad	Indoor	1.5 ft	7211
3 db Standard Gain ^(4 & 5)	Steel Mast	Indoor	1.5 ft	7210-3-UM
5 db High Gain ^(4 & 5)	Steel Mast	Indoor	3 ft	7210-5-UM
6 db Rugged High Gain ⁽⁴⁾	Fiberglass Mast	In/Outdoor	4.5 ft	7210-6-UC
7 db Rugged Higher Gain ⁽⁴⁾	Fiberglass Mast	In/Outdoor	6 ft	7210-7-US
9 db Central Station High Gain ⁽⁴⁾	Fiberglass Mast	In/Outdoor	8 ft	7210-9-UC

- Notes:
1. This antenna was evaluated by UL and approved for use in a UL 864 Edition 9 system.
 2. Included standard Tamper Resistant antenna, mounts on Alarm Unit’s enclosure. Includes cable.
 3. Mounts in attics, vents, walls, behind drapes, etc. Includes 10-foot cable.
 4. Requires cable (See [Section 1.10](#)). Usually requires user supplied mounting hardware such as a pole with mounting brackets/hardware.
 5. Antenna is intended for outdoor use, supplied mount is intended for indoor use as coax connection is exposed. To use outdoors, connection must be sealed with a suitable product such as a self-fusing tape to protect against moisture.

1.10 Coaxial Cable Options

- ◆ CABLES w/CONNECTORS, BNC ↔ N, for all AES Subscriber Units, high performance, low loss cables for all -UM, -UC and -US antennas above.

- **10 Ft RG-58 Cable, P/N 7220-10-N**
- **25 Ft RG-58 Cable, P/N 7220-25-N**
- **BNC Plug/connector (male) crimp style for RG-58 Coax, P/N 12-0102**
- **100 Ft. RG-8 W/1 N male (on spool), P/N 13-0345-100 - this coax is available for longer runs, cut to length and installer terminated.**
- **Loose connectors required to complete RG-8 assembly, P/N 12-0101**
- **Crimp tool required for 12-0101, P/N 7244**
- **Cable Assembly; 18” RG-58 (N female, bulkhead ↔ BNC male) Used to connect RG-8 with N male to Enclosure body, P/N 13-0346**

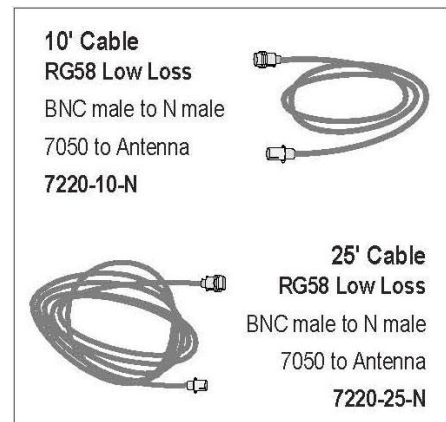

1.11 Coaxial Cable and Antenna Installation Tips

- Avoid using 25' of coax length if a 10' will be sufficient.
- Never use more than 25' of RG-58 cable in any antenna installation
- Always use shortest length of coax possible. Longer than necessary coax lengths translates into greater signal loss.
- Always use the straightest most direct routing possible in any coax installation. Unnecessary and tight bends adds to potential signal loss.
- Use 50 Ohm impedance coax only. Do not use 75 Ohm coax for the connection of remote antenna. RG-8, 9913, LMR-400, LMR-600 and RG-58 are among a list of acceptable 50 Ohm coax.
- RG-59 and RG-6 are 75 Ohm and NOT to be used.
- Use the proper coaxial connectors and crimp tool for the coax selected. Incorrect or poorly installed connectors can have a significant effect of the performance of the RF.

2 Commercial Fire and Burglary Installation Notes

UL Burglar Installations Tamper Protection: A UL Listed tamper switch that protects the cover against opening or removal is required on the 7744F installed in a burglar alarm installation. If the 7744F is installed outside the protected area, a tamper device is required to protect the enclosure against removal from the mounting surface.

Use a UL approved plunger type tamper switch, installed using holes drilled by the installer through the side and rear of the enclosure as suggested in Diagram below. Refer to diagram below, actual selected UL Listed tamper device and manufactures documentation for installation instruction and required hole pattern.

Wire tamper devices to a zone as outlined in the tamper device manufactures documentation and section 3.

The tamper devices must be installed and wired to activate a zone on the subscriber to generate an alarm signal at the central station.

In addition to installing tamper devices on the 7744F, a motion detector connected to the alarm control panel is required to protect the 7744F against attack.

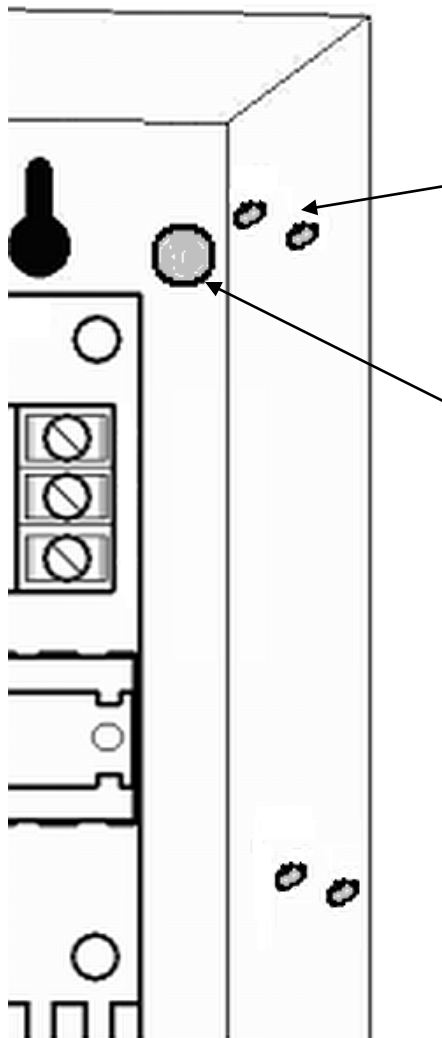

The 5 shaded holes shown in the diagram to the left indicate suggested locations for holes needed to install a typical UL Listed plunger type tamper switch.

Actual dimensions are to be determined from the actual switch and or switch installation instructions. Although the typical switch has three mounting holes available, two are sufficient to securely mount the switch.

A typical plunger type switch requires a 3/8" hole centered at the location where the plunger can protrude unhindered through the rear of the enclosure to make contact with the enclosure's mounted surface.



Several plunger type Tamper switches are shown above. The switch on the left is the style selected for the suggested hole patterns in the diagram to the left. The switch style on the right with built in mounting flange allows installation of a cover tamper without the need to drill holes.

Suggested Tamper Switch Mounting Locations

2.1 Power Requirements: 16.5 VAC, 40VA/45VA;

- For UL certificated burglar alarm installations, use the Listed AMSECO transformer P/N XF1640 or ELK P/N ELK-TRG1640 or TDC Power P/N DA-40-16.5 or MG Electronics P/N MGT1640
- For commercial fire alarm installations in the U.S., use the Listed AMSECO transformer P/N XF1640 or ELK P/N ELK-TRG1640 or TDC Power P/N DA-40-16.5 or MG Electronics P/N MGT1640
- Do Not Connect To A Receptacle Controlled By A Switch

2.2 Backup Battery requirement, Commercial Fire

- Central Station Fire Signaling (24hr): use a 12V, 7.5 AH battery when using 7744 by itself. Per this manual, Section 1.4.1, the capacity may need to be as high as 12 Ah when all modules are used.
- Remote Station Fire Signaling (24hr): use a 12V, 7.5 AH battery when using 7744 by itself. Per this manual, Section 1.4.1, the capacity may need to be as high as 12 Ah when all modules are used.

2.3 UL 681:

- Commercial Burglar Alarm Installation (4hr) use 12V, 7.5 AH battery
- Replace battery(s) every 3 years

2.4 UL 1610/365:

- For Burglar Alarm installations the 7744F unit shall be connected to a UL Listed central control panel such that opening and closing signals are provided.
- To provide confirmation of arming signal receipt at the central station, the DACT, integral with the Listed Control Panel, shall be used for Open/Close Reports.
- Set the Report Delay in the 7744F to 0 seconds.

2.5 7744F EOL Inputs / Zones:

- **EOL Alarm Inputs must be programmed for Supervised or Fire.**
- **For RF Type 6 Fire Alarm Systems, and Central Station / Police Connect Burglar Alarm Systems** - connect the J4 output of the 7744 Subscriber Unit circuit board to a non-reporting trouble zone on an FACP or some other method to annunciate the trouble at the premise. Refer to pages 16 & 18 for J4's location and additional information. Unsupervised. Contact rating 24 VDC, 1-Amp resistive maximum.

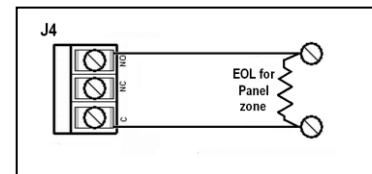

The wire connections between the control panel and J4 output must be supervised against opens, shorts and grounds.

- **For UL installations**, the wire linking alarm panel must use electrically supervised inputs (program the subscriber unit for Supervised or Fire Supervised accordingly).

3 Installation

This section contains information on the installation and wiring of the AES IntelliNet 7744F RF Subscriber Unit.

For Fire applications this product must be connected to a Fire panel that provides system status changes on a system wide basis for Alarm, Trouble and Supervisory at a minimum.

3.1 Overview

The AES 7744F combines the electronics of an AES Subscriber unit, battery, a radio transceiver and any approved modules such as the 7794, 7770, 7762 or 7067 into its enclosure. It is typically used to communicate alarm and status conditions of an alarm panel to a centrally located alarm monitoring facility via radio transmissions. A properly powered and configured AES 7744F will communicate with an AES Central Receiver via a locally provided AES IntelliNet Network.

3.2 Physical Installation

Installation Guidelines – Refer to Diagrams throughout this document for typical component installation locations.

- ◆ To comply with UL 365 Section 44, all wiring except the AC must use shielded wires. At least one end of the shield must be grounded.
- ◆ Choose an indoor climate controlled, secure, and dry location for the subscriber unit's installation.
- ◆ Avoid extremes of heat, cold, humidity, dust. Refer to range listed in specification section of this document.
- ◆ Mount enclosure to a suitable, strong surface using appropriate fasteners for the weight of the unit and the surface on which it is being installed.
- ◆ Pre-cut “knockout” type holes are provided on the back and sides of the case for wiring access. Knockouts are sized for standard ½ inch conduit connectors.
- ◆ For burglar applications, the unit should be located away from the alarm panel – hidden if possible – and within the protected area. This will aid in the successful communication of the intrusion even if the alarm panel is compromised.
- ◆ The supplied case top tamper resistant Flexible 2.5db antenna is mounted on the Subscriber's enclosure as shown in diagram 2 in this document.
- ◆ A separately purchased remote alternate antenna may be used with the 7744F Fire Subscriber Unit in UL installations. Contact AES for a selection of antennas suitable for use with your Subscriber Unit. Refer to [Section 1.9](#) for information on some available from AES.
- ◆ The antenna must be installed in accordance with National Electrical Code and local electric code.
- ◆ A protective surge suppressor must be installed in line with any type of remotely installed antenna.

- ◆ Mount antenna as high as possible, on or in the structure, with attics and rooftop locations preferred. Height need not be higher than is required to overcome nearby obstructions to the signal path if any additional height would use a longer coax length.
- ◆ A remote antenna should be mounted in a location near the transceiver to minimize inherent signal loss due to unnecessary cable length. Do not use longer coax than is needed to reach the antenna.
- ◆ Avoid installing the antenna in close proximity to other metal surfaces, as this may severely impact the performance of the radio communications due to the effects of signal reflections or detuning the antenna.
 - Remember that pipes, conduit, wiring, ductwork and other metal are commonly installed within walls and could affect performance.
 - Take into account foil backed insulation and wallpaper.
 - Metal objects may also be located in adjacent rooms or above ceilings.
 - Metallic framing is in common use today. Antenna should not be mounted directly over or in close proximity to metal studding.
 - Metallic supports are in common use today. Antenna should not be mounted in ceilings constructed of metal beams and supports that may interfere with the RF signal.
- ◆ The antenna must be grounded properly to help reduce damage due to surges produced by lightning. Grounding must be done in accordance with local building codes as well as those in accordance with any other authority having jurisdiction.
- ◆ When needed, use higher gain antenna with rated cable and connectors. Mount antenna as high as possible - attics that meet the temperature and humidity range specification can help to improve performance.
(See “[UHF Antenna Options](#)” listed in section 1.9 for available and approved options.)
- ◆ Antenna must be mounted in a vertical orientation.
- ◆ Avoid tightly coiled or bunched coax as this could also affect RF performance. Use Coax length that best fits the installation.

NOTE: During installation, the subscriber unit attempts to enroll itself into an available AES-IntelliNet network and if successful generates signals at the central station. Central station operators must be forewarned to avoid a false alarm.

3.3 Antenna Grounding and Surge Protector

Below is a diagram illustrating grounding and surge protector for the 7744F with a remote antenna installation.

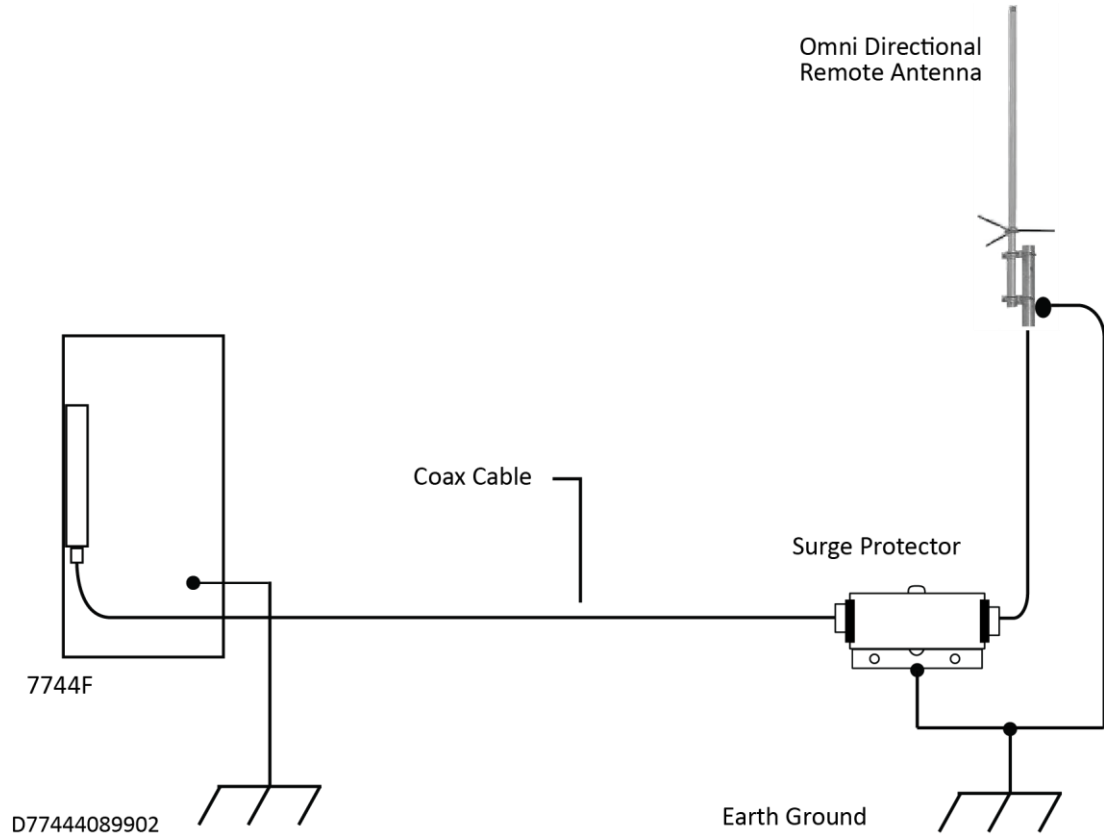

Illustration Below Shows the Enclosure Assembly

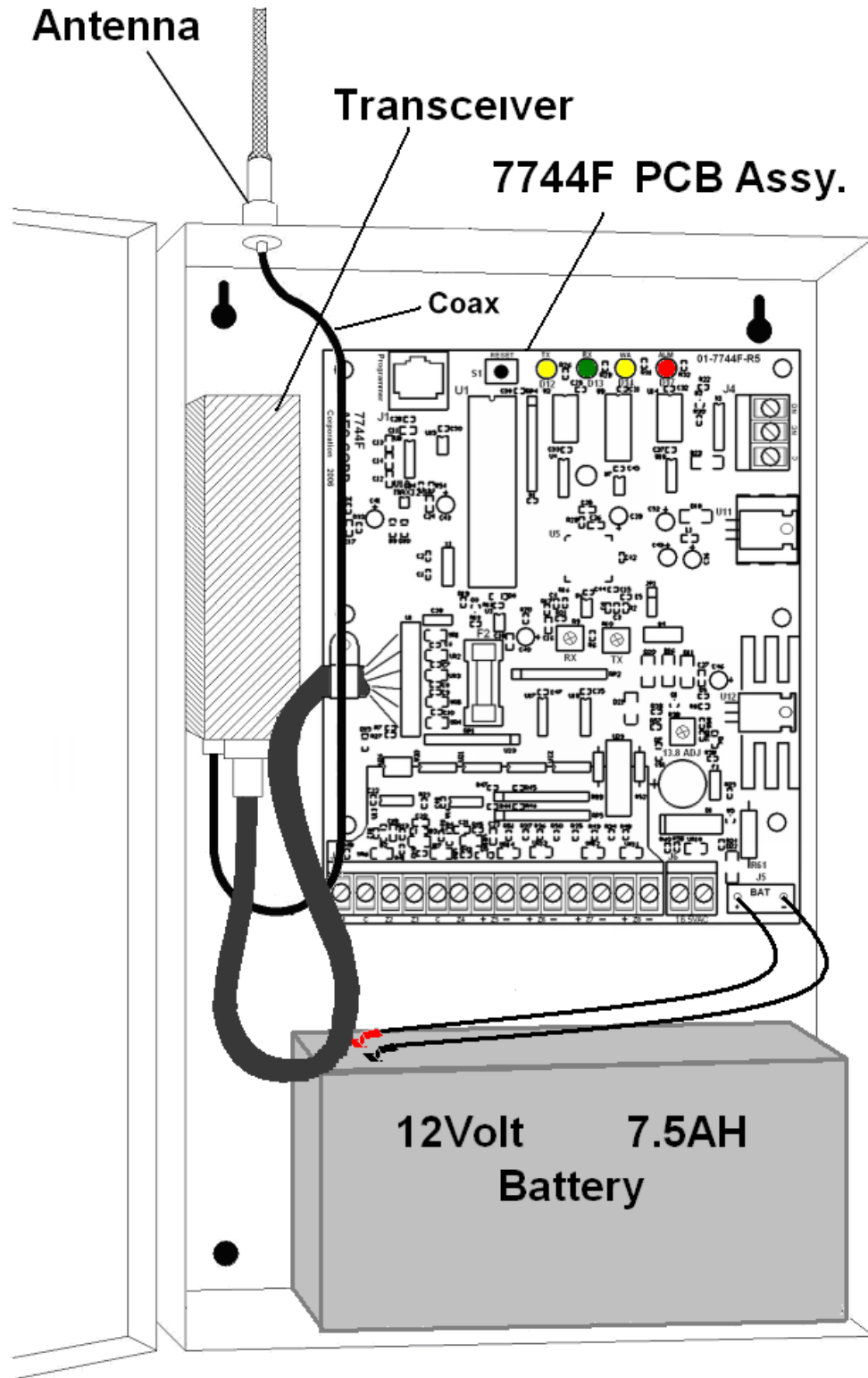
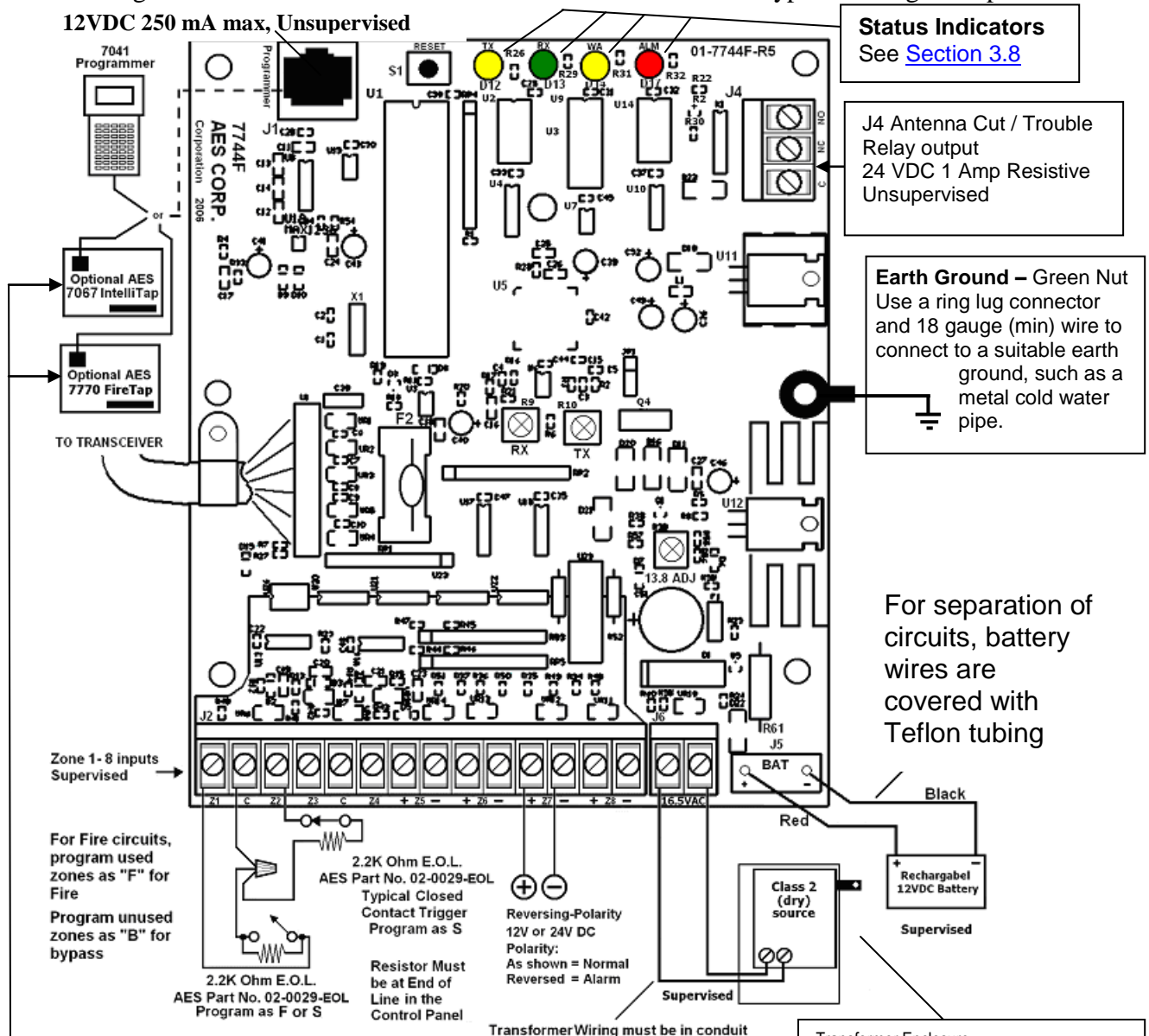

Diagram 2 – 7744F Enclosure Assembly

3.4 Wiring - General

Diagram below shows details of the 7744F board with some typical wiring examples.

12VDC 250 mA max, Unsupervised



Status Indicators
See [Section 3.8](#)

J4 Antenna Cut / Trouble Relay output
24 VDC 1 Amp Resistive Unsupervised

Earth Ground – Green Nut
Use a ring lug connector and 18 gauge (min) wire to connect to a suitable earth ground, such as a metal cold water pipe.

For separation of circuits, battery wires are covered with Teflon tubing

Zone 1-8 inputs Supervised

For Fire circuits, program used zones as "F" for Fire
Program unused zones as "B" for bypass

2.2K Ohm E.O.L. AES Part No. 02-0029-EOL
Typical Closed Contact Trigger Program as S
Resistor Must be at End of Line in the Control Panel

Reversing-Polarity 12V or 24V DC
Polarity: As shown = Normal Reversed = Alarm

Transformer Wiring must be in conduit

For Wiring Diagram of 7794 IntelliPro Fire
See: 40-7794 - 7794 Installation and Operation Manual
For wiring diagram of 7067 IntelliTap
See: 40-7067 - AES 7067 IntelliTap-II Manual
For Wiring Diagram of 7770 FireTap
See: 40-7770 - 7770 Installation and Operation Manual
For Wiring Diagram of 7762
See: 40-7762 - 7762 Installation and Operation Manual

Transformer Enclosure AES 1640-ENCL With Transformer
Power In: 16.5VAC, 40VA/45VA Class 2 (dry) source only. Use AES p/n 1640, or Amseco p/n XF1640 ELK P/N ELK-TRG1640 or TDC Power P/N DA-40-16.5 or MG Electronics P/N MGT1640

Diagram 3- User Connections

Terminals on J2 are not suitable for installation of multiple wires! Use a Wire Nut and Pigtail to connect multiple wires to a single terminal as shown in wiring diagram example above on terminal J2 position "C". See additional information on next page.

All wiring except the AC must use shielded wires with at least one end of the shield grounded.

- **J1 – RS-232 Port for Programmer and External Module connection.** Plug programmer's cable into this jack to perform programming functions. Programmer is powered by the power supply of the Subscriber. The AES IntelliTap, FireTap or other supported accessory modules are connected and powered by this jack. Any attached module must be disconnected to connect the programmer and the programmer must be disconnected to use a module. 12 VDC 250 mA maximum, Unsupervised
- **J2 – Zone wiring to this terminal block.** Zone wiring examples follow in Section 3.6. Zones 5 through 8 are for connection to power limited circuits. Terminals are not suitable for multiple wires. Use wire Nut and pigtail to connect more than one wire to a single terminal labeled G. Supervised
- **J4 – (Trbl) – Antenna Cut / Trouble output Local.** This is for local reporting or annunciating of antenna cut, communication troubles, low battery or charger fault. See Section 3.5 for details. Unsupervised. 24 VDC, 1-Amp resistive maximum.
- **J5 – Battery Input.** Attach 12 VDC battery to the Red **+** and Black **-** battery wires carefully observing polarity. An onboard self-resetting fuse protects Battery wiring. For separation of circuits, battery wires are covered with Teflon tubing. Supervised, Max current 1 Amp
- **J6 – Power Input.** Connect approved VAC power to this terminal block. Refer to [Section 4.3](#) for information on detection and reporting delays. Supervised.
- **Earth Ground** Earth Ground and Battery minus (-) are not separated connections in the AES IntelliNet 7788F Subscriber. Zone Input terminals including the "G" Terminals on J2 Zone input block are isolated from Earth Ground.

Using 18 gauge wire minimum (10 Ga. Min suggested), attach a suitable Earth Ground to the #6 threaded standoff identified with a green lock-nut on the inside of the enclosure. A superior method for connecting Earth Ground to the Subscriber is to bond directly to the bare sheet metal of the enclosure.

Suitable Earth Grounds include building steel, buried metallic cold water pipe, driven grounding rod and other grounding systems. Not suitable is the electrical ground from the electrical panel.

3.5 Wiring – Antenna Cut / Trouble Output (J4)

Antenna Cut / Ack Delay / Low Battery / Charger Fail Output

J4 is the output connector for the Form C Fail Secure Antenna Cut / Acknowledge Delay Relay / Low Battery / Charger Fail located on the 7744F circuit board. The 7744F will engage this relay for normal operation. It will be disengaged for one or more of the following reasons: 1) Reset, (remote or local) 2) non-powered condition, 3) Acknowledge Delay which will occur after an antenna cut or loss of communication with the network. An Acknowledge delay occurs when a Packet Acknowledge is not received for a transmitted Data Packet within the programmed Acknowledge Delay time. (Default Ack Delay Time is 60 seconds). 4) Low Battery or Charger Fail. Must be attached to an FACP or a local annunciation device.

If the Subscriber does not hear another transmission from any other unit on the network for more than 1-minute, (as might be the case if the antenna was cut), the Subscriber begins sending a test message to another unit ID from its internal routing table. If a Packet Acknowledge is not received for that test message within the programmed acknowledgment delay period (default is 1 minute or 60 seconds), a fault condition exists. This fault condition is annunciated by deactivating relay K1. The relay can be used to operate a digital dialer, sounder or local annunciation of the condition. The contacts of the relay are available at J4.

Max load is 1 Amp at 24 Volts DC, Unsupervised

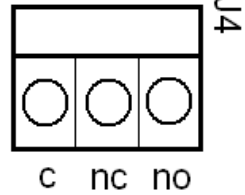

**Diagram 4 – J4
Antenna Cut / Trouble Relay**

3.5 Wiring – Antenna Cut / Trouble Output (J4) (Continued)

Trouble Annunciator

The AES 7740 Local Annunciator is the Space Age Electronics, Inc. Infinity Series Model IAMAUDK or IAMAUDR annunciator. This annunciator may be used to locally indicate Subscriber trouble condition using Trouble Output J4.

Connect the Model IAMAUDK/ IAMAUDR annunciator as shown in Diagram 4A below. Refer to the IAMAUDK/ IAMAUDR Installation Instructions p/n LT10452 for details on how to install the product within the constraints of its Listing. The IAMAUDK/ IAMAUDR requires Input power (terminals +, -) 21 – 30 Vdc, 65mA. The input power must be sourced from a Listed UL 864 FACP with a compatible power output circuit or UL1481 Power Supply Listed for fire protection.

The End of Line Supervision Relay must be Listed for UL 864 and input power rated for the application. The FACP must be Listed for UL 864 and input zone programmed for trouble with the correct End of Line resistance per its Listing.

The IAMAUDK is shown for illustrative purposes.

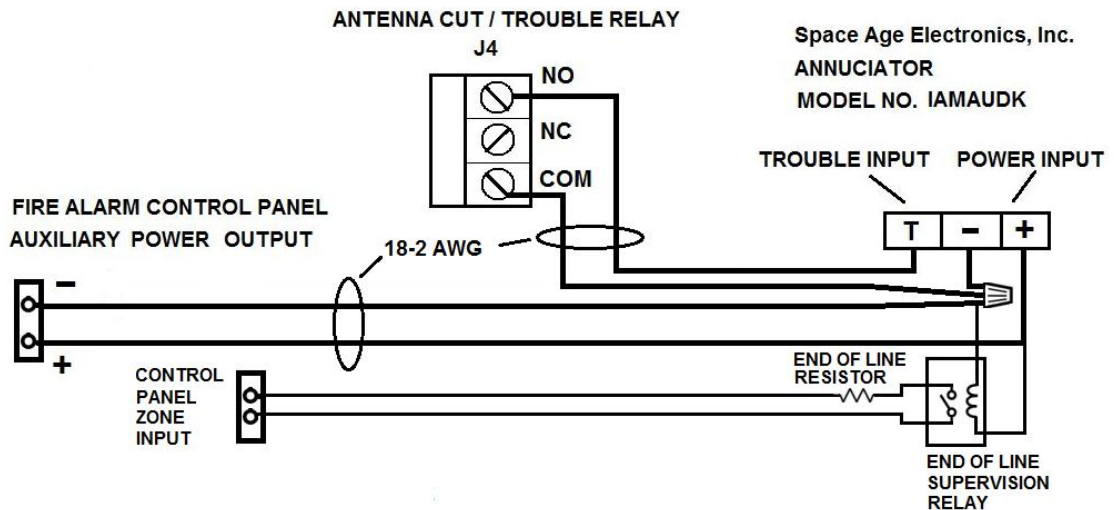

Diagram 4A – IAMAUDK Annunciator Wiring To J4 Antenna Cut / Trouble Relay

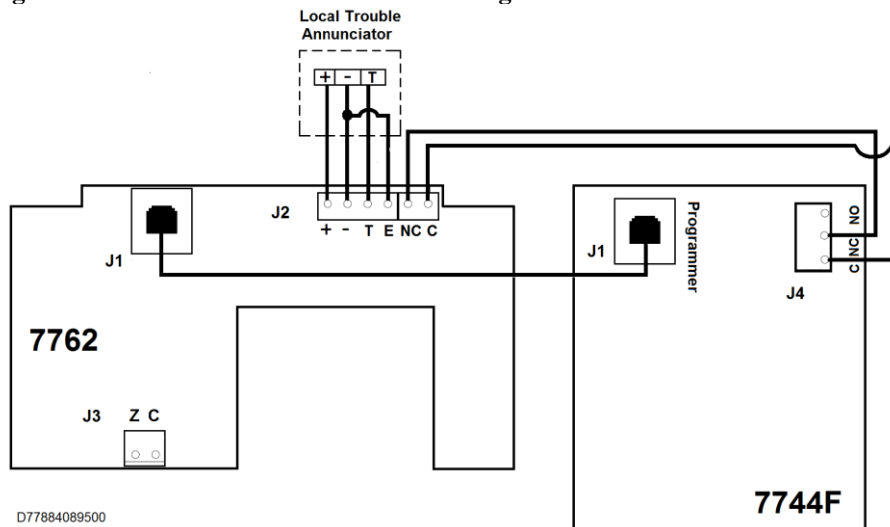

Diagram 4B – 7744F Powering IAMAUDK Annunciator Using 7762 Hardware Supervisor

3.6 Wiring - Zone Inputs

Following is an overview of the zone programming options. Use this to help determine the wiring option that best suits your requirements,

- Refer to illustrations on previous pages for location of Zone terminals.
- Zone inputs may be programmed for use with several types of outputs in alarm panels. Available options in the 7744F are, Supervised E.O.L. and Fire Supervised E.O.L. and either with or without Restorals. Fire Supervised refers to how the zone input behaves with an EOL device (similar to a typical fire circuit loop) and not specifically to it being used to report a fire alarm condition.
- Unused zones should be programmed as bypassed.
- Unused zones should NOT have EOL resistors installed.

The 7744F is intended for use in UL installations. The zone input wiring and programming is limited to appropriate configurations for that purpose.

Zone Programming →	S Supervised	F Fire	B Bypasses
Input Electrical State / Condition	Zone Status		
E.O.L Resistor 2.2K	N	N	B
Open	A	T	B
Shorted / Closed	A	A	B

B=Bypassed/Changes Ignored; N=Normal; A=Alarm; T=Trouble**

See [Section 4.4](#) for **Zone Programming Instructions**.

B = Bypassed - Zone Electrical State or condition is ignored

S = Supervised - EOL Resistor; 2.2K Ohm = Normal / Open = Alarm / Short = Alarm

F = Fire supervised - EOL Resistor; 2.2K Ohm = Normal / Open = Trouble** / Short = Alarm

**** NOTES:**

~ **Reporting of “Trouble” messages to AES Receivers other than the 7705i, 7703 and 7701 requires firmware version 1.70 or later.**

See Central Receiver Compatibility notes below.

Zone Reporting Chart

Notes on Central Receiver Compatibility

This Subscriber Unit is fully compatible with AES MultiNet Receivers, which are fully compatible with Trouble Packets. Trouble packets are also compatible with 7000 Series Central Receiver Versions 1.70 and up. Contact AES if your receiver is pre-1.70 for upgrade options. When “Fire” Zone programming is enabled, the unit generates a specific packet type for reporting “Trouble”. Data within this packet type can only be received on version 1.70 and newer receivers. Generally, any 7000 Series system shipped after 1997 would have a firmware version greater than 1.70. The 7705i MultiNet Receiver is fully compatible with Trouble Packets.

Notes on E.O.L. Resistance

Maximum resistance of E.O.L. input including wire and EOL resistor is 2400 Ohms. Thus, when using the 2.2K-Ohm resistor supplied, wire resistance must not exceed 200 Ohms.

Wiring Zone Inputs 1 thru 4 for EOL Operation (Supervised)

Zones 1 through 4 are wired for EOL operation by using a 2.2 K Ohm resistance in the wiring circuit to the zone for normal condition. Short the resistor to cause an alarm condition on zones programmed for “F”. Open the circuit to cause a trouble condition. Either short the resistor or open the circuit to cause an alarm condition on zones programmed for “S”. Wiring examples with suggested programming follows: The primary use of S programming simply disables the reporting of a Trouble message on an open circuit. S or Supervised is not related to Zone usage such as to report a Supervisory event.

The connections illustrated here are the minimum required for a UL Listed Fire installation.

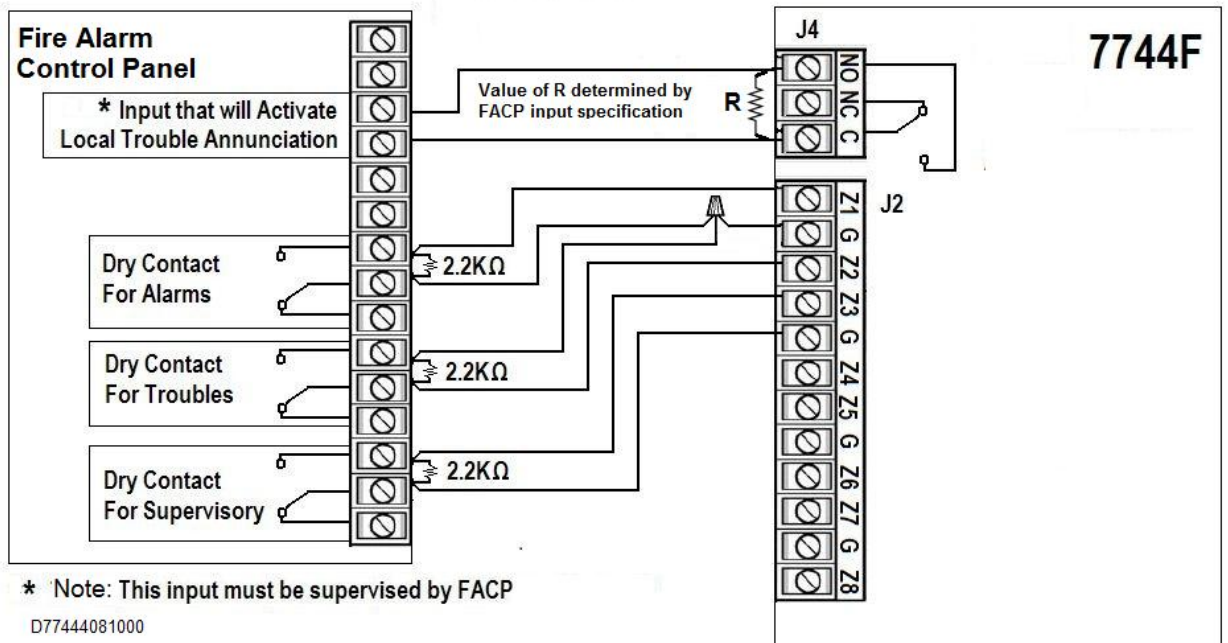

Wiring Reversing Polarity Inputs, Zone 5 thru 8 (Supervised)

Zones 5 through 8 are intended for connection to reversing Polarity outputs available on some Fire Alarm Panels. Assuming the programming of these inputs is as suggested (Fire), a Normal condition exists on the Zone when the 12 or 24 Volts DC produced by the FACP output are at the polarity as marked on the terminal block label of the 7744F. To cause an Alarm condition the polarity would reverse. A loss of voltage such as that due to a break in the circuit or power failure at the panel as detected at the Zone inputs would produce a Trouble condition.

Wiring example with suggested programming follows:

REVERSING POLARITY - Program for Fire "F"

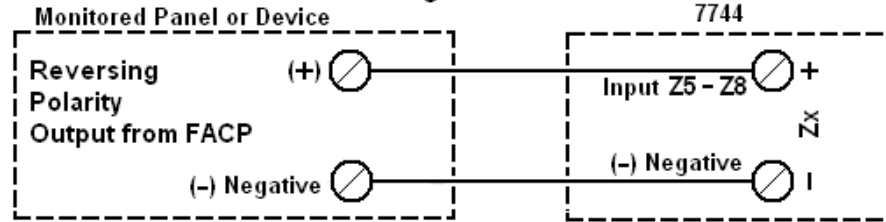

Monitoring a DC power source: These inputs can also be used to supervise any 12 or 24 Volt DC source. Connect polarity as marked, program for “F”. A trouble message will be sent, if the monitored DC voltage goes below 2.5 Volts DC.

Wiring Zone Inputs 1 thru 4 to Voltage outputs (Supervised)

(NOT APPROVED FOR USE IN UL or FIRE ALARM INSTALLATIONS)

Zones 1 through 4 can be wired such that they are controlled by electronic outputs. These include open collector and emitter follower types as well as other voltage outputs.

Wiring examples:

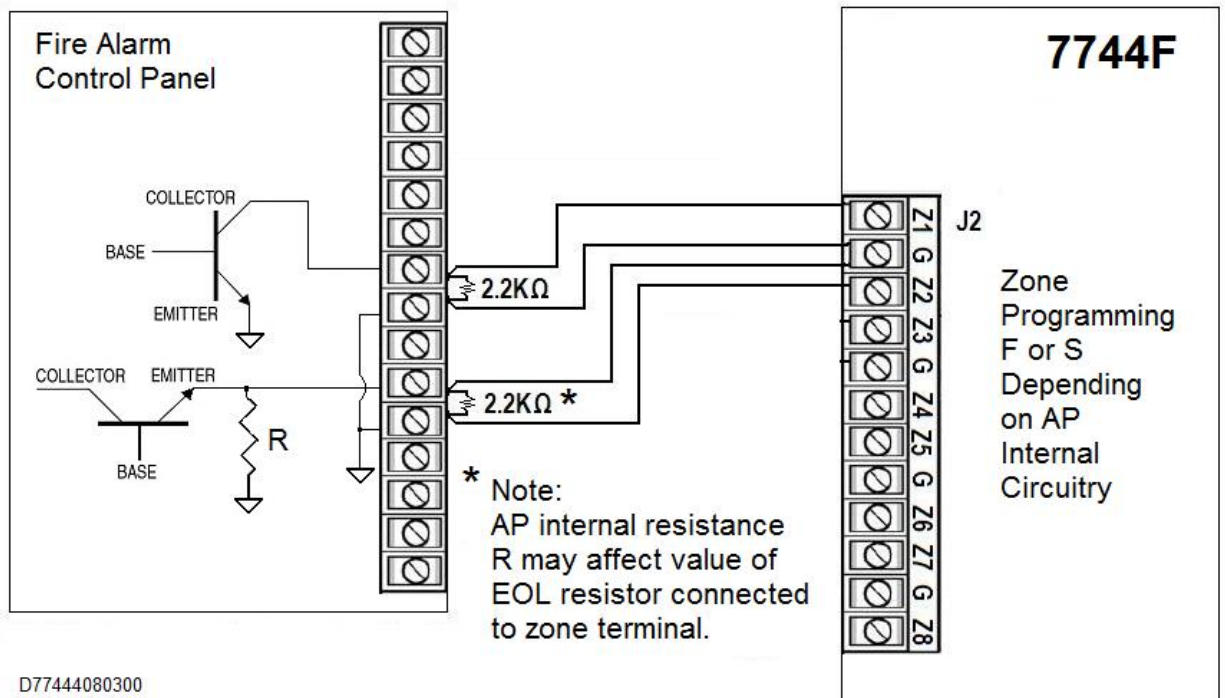

D77444080300

Wiring Open Collector and Positive Voltage Trigger Outputs

The wiring example illustrates several possible wiring models. Those illustrated assume that the load provided by the AP output does not change or affect the standard 2.2K resistance used as the EOL. The value of the EOL resistor may have to be adjusted to compensate for any load the panel output adds.

Select Resistor to provide a 2200 Ohm load on the input of the 7788F keeping in mind that circuitry in the alarm panel may have to be considered.

For more details, see the Dealer Support website at www.aes-intellinet.com

3.7 Power Up

Note: When a unit is powered up, it immediately attempts to enroll itself on an available *IntelliNet* network, generating signals to the central station. Central Station operators must be forewarned of this activity to minimize the chance of false alarms.

If using a programmer, connect it to J1/Programmer jack on the 7744F board. (See [Diagram 3](#)) With the 16.5V transformer de-energized or unplugged, connect the terminals of the 12VDC battery to the Red Positive (+) and Black Negative (-) battery leads from the BAT section on the 7744F board. The unit will energize.

Plug in or energize the transformer. Be certain that the power supply's power source is connected to a dedicated branch circuit. After AC power is energized, push the Reset button on the 7744F for a fresh restart of the program. The controller runs a "self test".

After a few seconds, a message will appear on the handheld programmer:

```
SELFTEST-PASS (or FAIL ###)
SUB [rev#] 7744F
ID#: [4 digit ID number] (C)YYYY AES
```

If the message reads SELFTEST - PASS, you may proceed with programming the unit. Note that the current ID# for this unit is displayed, as well as the firmware version (rev#) and copyright date (YYYY). If the message reads SELFTEST - FAIL [Error Code], retry the procedure by pushing the controller RESET button. If the Fail message persists, refer to Status Error Codes listed on the following page, for explanation and resolution.

Note: 001 = low battery. 100 = AC fail. 101 = AC fail with low battery. If the message reads SELFTEST – FAIL 001, you may proceed with programming the unit if the reported condition is expected and you know or feel that the battery has sufficient capacity to complete programming.

3.8 SELF-TEST / STATUS ERROR CODES

An [Error Code] is displayed on the screen of the programmer when the unit fails the self-test.

Push the reset switch to see if the problem clears.

If not, check these procedures.

Error Code	Description	Procedure
001	Battery power is low	Check battery; Push RESET button.
002	RAM Checksum failure	Push RESET button. See Note 1 below.
003	Problems 01 and 02 above	
004, 006	EEPROM Failure	Push RESET button. See Note 1 below.
008	Analog Digital Converter / ADC Failure	Same as 004 / 006 failure, see above
080	Loopback Test Failure	Push RESET button, unit will likely pass self test. See Note 1 below.
100	AC Not Present	Check AC power input, transformer
200	Battery Charge Fail	Unit may need servicing
300	Problems 100 and 200	Unit powered up by battery alone. If true, you may continue.
Other	Multiple errors are added	For example a Fail message of 084 indicates Loopback Failure and EEPROM fail (080+004). This example and other Messages may indicate that the unit requires AES authorized servicing. See Note 1 AC Fail with a low battery would report 101.
<p>Note 1: If unit passes, it must now be reprogrammed (see Section 4). If unit repeatedly fails Self Test with a message that is not related to AC fail or low battery, service may be required. Try performing a RAM RESET <Ctrl>+<F5> then <Y> then <Enter> This procedure may clear some errors.</p>		

Report the error code to AES service staff.

As a general rule, if the Self-Test fail is not a low battery, AC, battery charger or ground fault; then verify that any IC's installed in sockets are properly seated. Try performing a RAM Reset. If the fault is still present, the Subscriber will need to be returned to AES for service.

3.9 Status (LED) Indicators

There are 4 LED indicators on the main circuit board of the 7744F. The function of each is described below.

STATUS INDICATORS: LED's are located near the top edge of circuit board next to J1/Programmer connector and the Reset button.

LED	Color	Function
ALM	Red	Status / troubleshooting indicator, "blink" See chart below
WA	Yellow	Steady On = Waiting for acknowledgment of last transmission Steady Blinking = Not on Network; Off = Normal
TX	Yellow	Illuminated indicates radio transmit
RX	Green	Illuminated indicates radio transceiver receiving RF signal. Steady on for 20 seconds or more indicates RF interference. (Includes any radio activity on this frequency strong enough to break squelch)

Yellow - Green - Yellow - Red

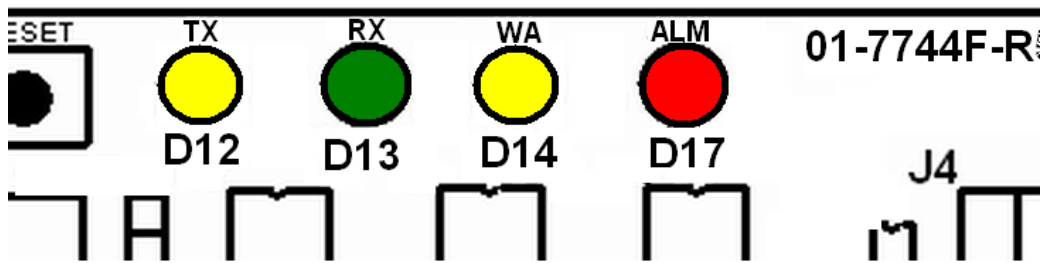

◆ Diagram 5 – LED Indicators

3.10 ALM LED Blink Pattern Chart

The chart below shows the various blink patterns utilized by the ALM LED, and what status conditions the blink pattern indicates.

Blink Pattern	Meaning
• 1sec • • •	Steady blink - system OK
•• •• ••	Short-short blink - low battery
•- •- •-	Short-long blink - an input zone is in alarm or trouble
••- ••- ••-	Short-short-long blink, low battery & zone in alarm/trouble
————	Steady / no blink - Self-test failure (excluding low battery)
Symbols as follows:	"•" = short blink, "—" = long blink Period between patterns is about 1 second with chart showing pattern repeated 3 times.

4 Programming

Programming is accomplished by attaching a compatible programmer to the J1/Programmer connector of the main circuit board. Following are programming instructions using the AES 7041 Hand Held Programmer. Unless noted, software at the AES central receiver can also be used to program some of the functions listed in this section, if remote programming has not been disabled as described in section 4.1 below. Refer to AES software documentation for remote programming instructions. A conversion chart for using a PC terminal program such as Hyper Terminal, as a programmer can be found later in this manual. Previously programmed information is stored in non-volatile memory, so the settings are not lost during a power down or power failure.

4.1 Remote Programming Limitations (Enable/Disable)

Note: NFPA 72 does not allow remote programming of an installed 7744F unless an authorized person is present at the unit to temporarily enable this capability.

Throughout AES documentation remote programming of AES Subscribers using software at the central station is mentioned. Remote programming of the 7744F is automatically disabled when the option to send Trouble Packets is selected in Zone Programming accessed by <Ctrl> + <F3> on the hand held programmer. **UL and Fire Alarm installations require Trouble Packets and “F” zone programming.** Trouble Packets are enabled when you select “Y” for the “Fire Trouble Packets” question in Zone programming. Fire Trouble Packets are also, automatically enabled if Remote Programming changes any zone to “F”.

See [4.4 Zone Programming](#).

Once remote programming is disabled as described above, the 7744F can only be programmed using the J1/Programmer Jack. Remote programming can be temporarily enabled for a 10 minute window after accessing the programming functions using <Ctrl>+<F1>, <Ctrl>+<F2> or <Ctrl>+<F3> via a programmer directly attached to the J1/Programmer Jack. Note that the 10-minute access window begins after completing the accessed function or when it times out in 65 seconds. Remote programming is not possible when any programming function is active.

To Enable Remote Programming: (Not for Fire Alarm Service type inputs)

- Selecting “N” for the “Fire Trouble Packets” question in Zone programming will enable remote programming.
- A RAM reset, which can only be performed with a directly attached programmer, will configure all zones to “S” programming, with no Restore messages sent, and “N” selected for “Fire Trouble Packets” question leaving remote programming enabled.

4.2 Program ID# and System Cipher Code

HandHeld Programmer: <Ctrl> + <F1> PC Terminal: <f>

The unit ID# and the system cipher code can only be changed using a directly attached programmer, to the J1/Programmer jack. Remote programming of these parameters are never possible.

NOTE: Entering new data overwrites (erases) any previously stored ID number and Cipher Code. Pushing the <ENTER> key without entering other new data preserves the previously stored information. The programmer should be connected and the power should be on.

To start, press programmer keys <CTRL>+<F1>.

The following message appears:

```

SETUP UNIT-OLD: NEW      (Existing stored "old" data.)
ENTER ID#-1234: . . . . (New data shown here.)
    
```

To keep previously stored ID#, simply push <ENTER>. To change the ID, enter the 4 digit identification number for this unit using any of the 16 hex numerals (0-9, A-F), and then press <ENTER>. **The ID must be unique; different from all other ID's in your system.** After successfully entering the ID, the following message appears:

```

CPHR CODE-XXXX: . . . . (Existing data is not shown.)
    
```

Enter the 4-digit cipher as assigned by the system administrator, and then press <ENTER>. The code must match that of the central station receiver or IP-Link it is expected to communicate through. If the wrong code is used, the unit cannot log on and will not communicate. After entering the cipher code, or pressing <ENTER> alone the following message appears:

```

OK
    
```

If the programming in this function is not completed within 65 seconds the function will time-out. The Programmer will beep and the following message will be displayed:

```

TIMEOUT
    
```

4.3 Timing Parameters (Check-In Time and Reporting Delays)

HandHeld Programmer: <Ctrl> + <F2> PC Terminal: <g>

This programming function is used to set the various timing parameters of the 7744F. The factory defaults are set to 24 Hour Check-In, 10 second reporting Delay and Random (RM) AC Fail reporting delay. If these are appropriate you can skip to the next section.

Use shorter check-in times for highest security applications only.

00 hours, 00 minutes is an illegal entry and will not be accepted.

- **Set Check-In as required for UL Listed installation. Configure automation software accordingly, to annunciate a failure to receive a Check-In message.**

The Reporting Delay sets the rate at which a subscriber's own signals are transmitted. The default value and recommended setting is 10 seconds; transmissions are sent at least 10 seconds apart (this helps to meter traffic on the system). The range is 0 (no delay, not recommended) to 330 seconds.

Note: After the reporting delay has expired, a new event will not have any delay and the attempt to send a new message will begin immediately after activation.

- **For all Commercial Fire Alarm and UL Burglar Alarm installations, the reporting Interval must not exceed 20 seconds.**

AC Reporting Delay sets the delay in minutes that a subscriber waits before AC Fail or AC Restore messages are actually transmitted after they are generated. This feature helps network traffic congestion in the event of an area wide power outage, by dispersing the AC Fail/ Restore messages over a period of 1 hour rather than all Subscribers attempting to transmit at the same time. If AC reporting is not suppressed, this feature delays the reporting of and AC Fail message for a random or fixed delay. AC suppression is not approved for use in a UL installation.

- **The combined AC Fail Detect time of 100 minutes, plus the random AC Report Delay between 0 & 60 minutes, does not exceed 160 minutes, which is within the UL specification of 3 hour (180 minutes) maximum for reporting AC Failures.**

A loss of AC must exist for approximately 100 minutes in order to be detected as a fail. The AC must be restored for 100 minutes to be detected as a restore. Once either is detected a message is created to send to the central station. Then an AC Reporting Delay is selected based on this parameter and the setting of AC Fail Suppression mentioned later in [Section 4.5 - Set Modes](#). The default value is RM, which selects a random delay between 0 and 60 minutes.

The available options are: RM for random or you can enter a fixed delay in minutes. 0 = no delay and results in operation similar to earlier versions of AES AC Reporting. The reporting of AC can be completely suppressed using a programming option in Set Modes ([See Section 4.5](#))

To Start, press programmer keys <CTRL>+<F2> (hold down the Control and the F2 keys at the same time). The following message appears:

```
CHKIN TIME--OLD:NEW
ENTER HRS----HH:..      [00-24] (HH = existing data)
```

Enter a number of hours between 1 and 24 (default = 24) and press <ENTER>.

```
ENTER MINS---MM:..      [00-60] (MM = existing data)
```

Enter the number of minutes between 0 and 60, then press <ENTER>.

```
AC RPT TIME-OLD:NEW   [RM] Random or [00-60] [Minutes]
ENTER MINS---RM:..
(Report Delay, RM = existing programmed data)
```

Enter a number of minutes to delay AC Fail/Restore transmissions; the range is 0 to 60 or RM; the default is RM for Random.

Then press <ENTER>.

```
NTR RPT DLY-NNN:...    [0-330] [seconds]
(Report Delay, NNN = existing programmed data)
```

Enter a number of seconds to allow between transmissions; the range is 0 to 330; the default (and recommended) is 10 seconds. Then press <ENTER>.

If data has been entered correctly, the following message appears:

OK

If the programming in this function is not completed within 65 seconds the function will time-out. The Programmer will beep and the following message will be displayed: **TIMEOUT**

NOTES ON SELECTING A CHECK IN TIME:

- Choose a check-in time in accordance with the security requirements of the installation.
- Except for high security applications, a check in time of 24 hours is typical. The more frequent the check in times are set, the more traffic there is on the network.
- Do not attempt to use a check in time of greater than 24 hours, 00 minutes.

4.4 Zone Programming

HandHeld Programmer: <Ctrl> + <F3> PC Terminal: <h>

The 7744F zone inputs are connected through a special isolated circuit. It is linked to the processor through optical couplers to keep unwanted energy from entering the main circuits.

Zones 1-4 are E.O.L. input triggers, which can be programmed for:

- E.O.L. / Supervised, using 2.2K end-of-line resistors, alarm on open or short
- E.O.L. / Fire Supervised, reporting trouble for open circuits, alarm on short
- Bypass, where the zone input is ignored.

Zones 5-8 are reversing voltage inputs, which are used to monitor reversing polarity output used on fire alarm and other equipment. Programming Options:

- “S” (Supervised), reports alarm when input polarity reverses or if there is low or no voltage on the input.
- “F” (Fire) programming, Reports Alarms when input polarity reverses, and reports a trouble if there is low or no voltage on the input.
- Bypass, where the zone input is ignored.

For Fire UL installations, the wiring of any FACP’s relay output to any 7744F zone input must use an EOL / electrically supervised zone programmed with "F". On the 7744F, Zones 1 through 8 meet this requirement. Supervision of the zone inputs must be in compliance with the requirements of NFPA 72. The default setting is “S” for Supervised and must be changed to “F” for Fire supervised.

To permit the reporting of a Trouble condition in a “Trouble” message, “Fire/Trouble PKT” (Fire Trouble Packet) must be enabled by selecting “Y” to the first prompt in Zone programming. See Section 4.1 “Remote Programming Limitations” for additional information on setting this parameter.

Zone Restorals: Each zone can be programmed to report “Restoral” to a normal state. The default setting is “X” for "No" Restorals.

Factory default zone programming is set to **(N)** for no Fire Trouble, **(S)** for EOL Supervision and **(X)** for no Restoral. If this is satisfactory skip to the next section.

UL installation must be changed to “Y” for Fire Trouble PKT and “F” for Fire Supervision.

Important Note: The 7788F **MUST** be reset after making changes to the Zone Programming! This allows the unit to initialize reading its zone inputs based on its current programming and clearing any former conditions that remain in memory before any changes were made. Failure to do a Reset may result in such confusing reports as an Alarm or Trouble on a zone that was changed to Bypass.

To start, press programmer keys <CTRL>+<F3> (hold down the Control and the F3 keys at the same time). The following message appears:

```

FIRE/    ----OLD:NEW
TROUBLE PKT- N:  .           [Y/N] (N = existing data)
    
```

The sequence first asks if "Fire Trouble Packets" are to be sent. Answer Y/yes if you wish to have the 7744F report "Zone Trouble" conditions. Otherwise answer N/no. The existing programming is shown under the "OLD: " column. If you wish to change the setting, enter Y or N. To leave unchanged, simply push <ENTER>. Based on your response to this first parameter the available options for Set Zone programming will vary.

Note: Answering “Y” to this question disables remote programming from central station software. See [Section 4.1](#).

After pressing <ENTER>, the following appears:

```

ZONE BANK 0  .
SET ZONE (BSF) B0      (available options)
OLD SSSSSSSS LOW>HI   (S, F or B = existing data)
NEW  . . . . .        (Must enter exactly 8 values)
    
```

The available and valid Zone programming options are shown in the parentheses on the display as shown above. The options that appear are determined by your input to the "Fire/Trouble PKT" question above. The current programming is shown next to the word OLD, Zones 1-8 in order left to right. Your new entries will appear directly below next to the word NEW. You must enter a valid letter for each of the 8 zones. Zones programming 1-8 can be set for: Entering more or less than 8 characters will result in repeating the above response.

B - Bypassed

S - Supervised/E.O.L. (alarm on open or short);

F - Fire Supervised E.O.L. (alarm on short, trouble on open) Required for UL Fire

After successfully entering Set Zone data, the following appears:

```

SET RESTORAL (XR) B0      (available options)
OLD RRRRRRRR LOW>HI     (R or X = existing data)
NEW  . . . .            (Must enter exactly 8 values)
    
```

The option to select individual zones to report returning to a normal state is available. X = Restore Not Reported; R = Restore Reported. The existing or OLD programming is shown for each zone. Your new entries will appear directly below next to the word NEW. You must enter a valid letter X or R for each zone. Entering more or less than 8 characters will result in repeating the above response.

When restore data entry is complete, Press <ENTER>. If data has been entered correctly, the following message appears:

OK The zones are now programmed

Programming must be completed within 65 seconds or function will:

TIMEOUT

4.5 Set Modes – Enable Repeating and Suppress AC Fail

HandHeld Programmer: <Ctrl> + <F4> PC Terminal: <i>

There are several functions that can be programmed in the Set Modes programming area. Repeating can be disabled and AC Fail Reporting can be suppressed.

To Start, press programmer keys <CTRL> + <F4> (hold down the Control and the F4 keys at the same time). The following message appears:

SET MODES--OLD: NEW

ENABLE RPTNG-Y: .

Enter Y to enable repeating capability. Default is Y.

Press <ENTER> then the following appears:

SPRSS ACFAIL -N: .

Enter Y/yes to suppress the reporting of AC Fail messages, enter N/no (the default and setting required in UL installations) to disable the feature and allow normal reporting of AC Fail messages. Default is N.

Press <ENTER>, If data has been entered correctly, the following message appears:

OK

If the programming in this function is not completed within 65 seconds the function will time-out. The Programmer will beep and the following message will be displayed:

TIMEOUT

Refer to Section [4.3 - Timing Parameters](#), for information on and programming the AC Reporting Delay that determines when the AC Fail is reported after it is detected. Reporting AC Fail is normally a very important message and should not be suppressed. UL installations require this setting to be set at “N”.

4.6 Reset RAM

Use the Reset RAM function to return the 7744F to the factory default settings. All parameters except the Unit ID and Cypher code are returned to default values.

It is good practice to perform this function on a new factory unit to ensure that you are always starting from the same configuration. Also perform this function if this is a reinstallation of the unit, if you are unsure of the configuration or if you are having other problems with the unit.

Press <CTRL>+<F5> then Y then <ENTER> to complete this operation.

The Unit will initiate a Self-Test after the values are reset.

4.7 Initializing the Subscriber Unit

Having programmed the unit, you are now ready for a final check. Plug in the handheld programmer if available. Push the Reset button on the controller board (See [Diagram 3](#)). At this point, the message on the programmer should read:

```
SELFTEST - PASS
SUB [rev#] 7744F
ID#:NNNN (C) [date] AES
```

If a "Fail" error message other than 001, 101, 300 or 301 is displayed, push the reset button. If the error persists, refer to [section 3.7](#), which contains a list of error codes.

The status lights indicate the progression as the subscriber unit goes on the air and attempts to enroll into the network.

Details of automatic Network log on sequence after a reset:

- STATUS INDICATOR LED's RX, TX and WA lights come on briefly, testing the LED's.
- RX comes on briefly during loop back test (a self test).
- TX comes on sending a "Receiver Not in Service" message - AL + WA blink at different but steady rates.
- TX comes on as unit transmits a "Request for Reply".
- WA stops flashing after about 15-30 seconds if one or more other subscriber units reply to the "Request", (otherwise the WA continues to flash, indicating the unit is not on the network).
- TX comes on again (if WA stops flashing) to send first message.
- AL blinks at a steady rate, indicating a normal condition.
- When the unit receives a valid acknowledgment, the WA light turns off. This indicates that the reset or powered up 7744F unit is now on the network.

◆ **IMPORTANT NOTE: A flashing WA light (blinking at a steady rate) indicates that the subscriber has NOT linked itself into the network.**

If enrollment fails, check antenna and all cables; be sure that correct system cipher has been programmed in to the unit. Once the Subscriber is enrolled in its network, additional testing can commence. At this point, with the WA off, the Subscriber has passed the initial RF operational test.

4.8 Local Status Check

HandHeld Programmer: <SHIFT> + <F4> PC Terminal: <d>

This function performs a quick diagnostic check at any time. Use the handheld programmer: press <SHIFT>+<F4>. The following message appears:

```
SUB [rev#] 7744F
ID#: [NNNN] (C)YYYY AES
RT1:NNNN LEVEL: NNN
STAT:NNN NETCON: N
```

EXPLANATION OF STATUS CHECK TERMS

Top Line: Indicates Subscriber model and firmware revision information.

ID#: 4-digit ID number programmed into this unit.1

YYYY: Indicates Copyright year.

RT1: Route #1, the ID of the first Subscriber that will be attempted in route to the central station. If RT1 is 0000 or an IP-Link ID, the unit is attempting to communicate directly with the central station or IP-Link. If XXXX appears, the unit is not on the network. Any other 4-digit ID indicates the unit at the top of the routing table.

Dynamic Routing Table: Each subscriber unit maintains a list of up to 7 alternate IDs. IDs are prioritized according to signal strength and NETCON ratings. This function is dynamic, and is updated constantly.

LEVEL: Refers to the subscriber unit “level” or “link layer”, which suggests the expected number of “hops” the message packet might make to get to the central station or IP-Link. In general, if the number is 1, then this unit is attempting communication directly with the central station or IP-Link. If the number is 2, the unit expects to relay its message through one other subscriber unit to reach the central station or IP-Link. If the number is 3, the message goes through 2 other subscribers ... and so on. Also, the level number of subscriber with a weak signal to the unit on the top of its routing list will be incremented by 1. A unit level = 255 indicates that unit is not on network.

STAT: Status shows the self-test data
(Refer to [Section 3.7](#) for explanation and resolution.).

NETCON: (NETwork CONnectivity) An internal rating used in the automatic positioning of this unit in the network. The range is from 0-7, 0 being best. Note that while a low number is better, any NetCon from 0 to 6 is OK. 7 may indicate a problem with this unit or a unit in its path to the central receiver.

All Fire Alarm installations require a NETCON of 0 to 5

Minimum criteria for a "good" repeater are as follows:

1. RF signal exceeds good threshold
2. No faults indicated in status (such as low battery)
3. Level/Link Layer of Subscriber/IP-Link is less than or equal to this unit's
4. Signal received from Subscriber/IP-Link at least once every 6 hours

4.9 Monitor and Key Transmitter Functions

HandHeld Programmer: <SHIFT> + <F1>, <SHIFT> + <F2>, <SHIFT> + <F3>
PC Terminal: <a>, , <c>

There are several functions that are useful for diagnostics purposes. These functions allow the viewing of network data “traffic” that is picked up by the Subscriber’s RF antenna and viewed on the programmer’s 4-line display at the installation site. It is not practical to “read” this data on a Hand Held Programmer as it may scroll off the screen to quickly, but it can be useful to confirm that data is being sent and received. Use a Terminal with a larger screen such as a laptop with a Terminal Program to take better advantage of these functions.

RECEIVE MONITOR ON/OFF

To use: Push programmer keys <SHIFT>+ <F1> PC Terminal: <a>

RX MONITOR ON (OFF)

Hold down the Shift key and then press the F1 key to enable or disable (toggle) the display of data addressed to this unit.

TRANSMIT MONITOR ON/OFF

To use: Push programmer keys <SHIFT>+ <F2> PC Terminal:

TX MONITOR ON (OFF)

Hold down the Shift key and then press the F2 key to enable or disable (toggle) the display of messages transmitted by this unit.

MONITOR ALL ON/OFF

Note: requires that Receiver Monitor above must be on - <SHIFT>+<F1>.

To use: Push programmer keys <SHIFT>+ <F3> PC Terminal: <c>

MONITOR ALL ON (OFF)

Hold down the Shift key and then press the F3 key to enable or disable (toggle) the display of all network messages within range of this unit.

The monitor functions should be disabled when installation and testing is complete.

Note: Text messages cannot be received when any of the monitoring functions are in use. Use these functions only for diagnostics or test purposes. Toggle the function OFF when not in use, or press the Reset Button, as a reset will return all these functions OFF. See [Section 3.3](#) for location of Reset Button.

4.10 KEY TRANSMITTER

HandHeld Programmer: <SHIFT> + <F5> PC Terminal: <e>

This function activates the transmitter for about 5-6 seconds. This allows the installer to use external test equipment (SWR, power meter, etc.) to test the radio power, cables connections, antenna tuning and other radio parameters. It is assumed that the programmer is connected to the subscriber, the transceiver is connected to the subscriber circuit board, power is on and the antenna is connected.

To use: Push programmer keys <SHIFT>+ <F5> PC Terminal: <e>

KEYING TX. .

Hold down the Shift key and then press the F5 key to activate the transmitter for 5 seconds. After the 5 seconds a TIMEOUT message will display. Press <ENTER> before the 5 second timeout to abort in which case OK will be displayed.

Activating this function causes the transmitter to go on the air for 5 seconds, and then shut off automatically. Press the ENTER key to cancel an active transmit test.

4.11 Display Zone Status

HandHeld Programmer: <Ctrl>+<Z> PC Terminal: <Ctrl>+<Z>

Use this function to review the current state of each of the Subscribers Zone inputs based on its programming and input state.

Zx##, Z1-8:####-####

Zx## - This is a Hexadecimal number representing the binary bit pattern of the Zones input condition. I.e. Hexadecimal 12 = binary 00010010. Bit positions 2 and 5 are 1 indicating that those zone positions are in alarm.

Z1-8: The row of characters represents in order, each individual zone state.

####-#### - Each character represents the Status of a specific zone, displayed left to right for zones 1 to 8, separated between position 4 and 5 with a hyphen.

Possible Values - 0 = Normal, 1 = Faulted, Not Normal or Alarm, T = Trouble.

4.12 Display Routing Table

Use this function to display up to the 8 ID's that are listed in this Subscriber's current Routing Table.

To use: Press programmer key <F4> or PC keys <Ctrl> <T>

4.5678 , L:02, N:5, Q:83	unit 5678, Weak signal (8x)
3.7888 , L:01, N:5, Q:03	unit 7888, Good Signal
2.BB12 , L:00, N:0, Q:03	an IP-Link BB12, Good Signal (03)
1.AA11 , L:00, N:0, Q:03	an IP-Link AA11, top of the list = RT1

Press F4 on a HHP or Ctrl + T on a PC to display Routing Table information. Only up to the top 4 are visible due to limitations of the HHP's 4-line display. A PC displays the entire table up to 8. The order is reversed so that the most significant top 4 will remain on the display of the HHP where 5 through 8 would have scrolled off.

Fields displayed left to right are, Preference or sort order (1.-8.), ID, Link Layer or Level:##, NetCon:# (0-7), Signal Quality:## (03 = Best , 81 = worst)

Routing Table – A Routing Table is a list of up to 8 IDs that a Subscriber maintains for selecting the ID to pass its data packets on through. It is sorted so that the best ID is at Preference location 1. If no Packet Acknowledge is received after attempting transmissions

to the #1 seven times, the #1 ID is removed from the Table and all other's preferences are incremented by 1. Transmission attempts resume using the new Preference 1 ID.

Link Layer or Level – Link Layer as reported by last transmission from ID. Value displayed in the table will be incremented by 1 if the Signal Quality is not “Good” or there are faults reported by the ID. Link Layer is the number of hops a data packet would need using the ID as first in the route, assuming all IDs in the route successfully used their Preference 1 IDs as well.

NetCon – Briefly it is a confidence number where the lower the number, the more confidence a Subscriber should have in the ID's ability to pass the packet on as lower numbers indicates healthier routing tables with more options. In UL 9th Edition compliant units the NetCon is used as a multiple path indicator, not lower than 5.

Signal Quality – The first digit is either an 8 or a 0. 0 means Carrier Detect (CD) was on during signal reception. 8 means it was off. CD is related to signal strength where it is on when the strength of the signal is above a certain threshold. The second character is related to readability of the data. 3 is the best indicating all three of the data repeats were properly read and 1 is the lowest meaning that only one of the three was. Therefore a Good signal would read 03 and a Marginal would be 82 or 81.

4.13 Text Messages

SENDING TEXT MESSAGE

Text messages can be sent from the subscriber unit to the central station.

To use: Push programmer key <F5>

ENTER MSG:

[Enter your text message, up to 200 characters. Push <ENTER> to send.]

If no data is entered within approximately 65 seconds, the unit will exit the text message mode.

Note that the unit is unable to transmit or receive while in this mode.

RECEIVING ASCII TEXT MESSAGES

Messages can be sent from the central station to any subscriber unit. If the handheld programmer or other properly configured serial terminal is connected to the unit's J1/Programmer jack, the message will be displayed on the screen with a beep sound. This is a handy feature for communications between installers and central stations and to test how quickly communication occurs.

Note: Text messages cannot be received when using any of the monitor functions.

4.14 Handheld Programmer – Quick Command Guide

Handheld Programmer Commands

CTRL+F1	SETUP UNIT - ID#, Cipher
CTRL+F2	SET TIMERS - Check-In Interval, AC Report Delay
CTRL+F3	SET ZONES - Supervised/Fire/Bypassed/Restoral
CTRL+F4	SET MODES – Repeating, AC Fail Suppression
CTRL+F5	RESET RAM - Y/N, resets factory defaults Except ID# and Cipher
SHFT+F1	RX MONITOR ON / OFF (toggle)*
SHFT+F2	TX MONITOR ON / OFF (toggle)*
SHFT+F3	MONITOR ALL ON / OFF (toggle)*
SHFT+F4	TEST STATUS
SHFT+F5	KEY TRANSMITTER (5 seconds)
F5	SEND TEXT MESSAGE

* Turn off monitor functions when done (or press reset button)

4.15 Reconnect Cables after Programming

After programming is complete, reconnect any cable (such as the cable to the AES IntelliTap), disconnected from J1/Programmer jack of the main circuit Board.

4.16 Programming the Subscriber Unit from a PC

In place of a handheld terminal, a cable adapter kit #7043E may be ordered from AES to link the 7744F to your computer's serial port.

Communications Parameters: 4800 baud, NO parity, 8 data bits, 1 stop bit, RTS/CTS Flow control OFF

Handheld (HH) Programmer Key equivalents to (PC) Keyboard:

HH	PC	HH	PC	HH	PC
F1 = CTRL-Q		SHIFT F1 = a		CTRL-F1 = f	
F2 = CTRL-R		SHIFT F2 = b		CTRL-F2 = g	
F3 = CTRL-S		SHIFT F3 = c		CTRL-F3 = h	
F4 = CTRL-T		SHIFT F4 = d		CTRL-F4 = i	
F5 = CTRL-U		SHIFT F5 = e		CTRL-F5 = j	

- When entering Hex numbers, use uppercase, i.e., "9A" not "9a"
- If possible, set terminal program for destructive backspace" so that backspace will erase the deleted character from the screen.
- If nothing is sent or received by the subscriber, make sure the program is set to the correct COM port.
- If the subscriber receives characters, but nothing can be sent, make sure the CTS/RTS flow control is OFF, and that the cable is OK.

5 Testing

Before leaving the installation site, you want to test that the expected signals are properly getting to the monitoring system. Perform at least the tests below and confirm that the monitoring system and personnel properly received the correct messages and understand what they mean.

5.1 Installation Site Checks

Some of the tests to be performed at the installation site require a response from a Central Station person.

- Trigger alarm conditions and confirm that the proper message is received at the Central Station.
- Cause fault conditions and confirm that the proper message is received at the Central Station.
- Activate devices that will utilize any accessories such as the IntelliTap to confirm that these devices are functioning as desired.
- Activate devices that will utilize any accessories such as the IntelliTap or IntelliPro to confirm that these devices are functioning as desired.
- Perform a Status Check, <Shift> + F4 to confirm good Status and required NetCon.
- Review Routing Table, <F4> to evaluate the listed IDs and values.
- Ctrl + T to check current Zone state

5.2 Acknowledge delays

An Acknowledge delay occurs when a Packet Acknowledge is not received for a transmitted Data Packet within the programmed Acknowledge Delay time. (Default Ack Delay Time is 60 seconds).

Visit the Technical Support Knowledgebase for additional information on this and many other subjects.

6 Maintenance, Compliance, Warranty and Repair

Once installed and normal operation is confirmed, there is typically little maintenance required. Monitoring the automatic test messages will confirm proper RF operation. Batteries should be periodically tested to be certain they have sufficient capacity to operate the system as needed.

6.1 Troubleshooting

The most common causes of an RF failure or trouble are due to issues with the transmission line including but not limited to the antenna type, antenna location, coax, connectors, and transceiver. Antennas in close proximity to metal or with conductive material blocking or reflecting the transmitted signal would be at the top of the list. Observe the RX light on the main circuit board. If it is on steady or most of the time you may be receiving some RF or electrical interference. Try different locations for the antenna or use a remote long range RF antenna. Try replacing the transmission line components such as a new transceiver, coax and antenna.

Problems on the circuit boards usually require returning the defective unit to AES for service.

6.2 Parts List

- The standard 7744F Subscriber includes the following items.
 - Enclosure
 - 7744F Circuit board assembly
 - 7085UE Transceiver at licensed or authorized frequency
 - 7214 Tamper Resistant Antenna Assembly and cable
 - 40-7744 Instruction manual
 - 02-0029-EOL Qty. Four 2.2K Ohm E.O.L. Resistors

6.3 Contact Information

AES Corporation
285 Newbury Street
Peabody, Massachusetts 01960 USA
Website: <http://www.aes-corp.com>
AES corporate Phone: (800) 237-6387 (800) AES-NETS
USA (978) 535-7310
Fax: USA (978) 535-7313
Email: Check Website for latest email addresses

6.4 Warranty and Service Procedure

OWNER WARRANTY - AES CORPORATION LIMITED PRODUCT WARRANTY AND TECHNOLOGY LICENSE

LIMITED PRODUCT WARRANTY:

AES Corporation (“AES”) warrants to the original purchaser that each AES Subscriber Product will be free from defects in material and workmanship for three (3) years from date of purchase and all other products purchased from AES including central station receivers and accessories will be warranted for one (1) year from the date of purchase. At no cost to the original purchaser for parts or labor, AES will repair or replace any AES Product or any, part or parts thereof which are judged defective under the terms of this Warranty.

Defective AES Products must be returned to AES directly, provided they are properly packed, postage prepaid. Or exchange may be made through any authorized direct factory representative for any AES Products that are judged defective under the terms of this Warranty. Improper or incorrectly performed maintenance or repair voids this Warranty. This Warranty does not cover replacement parts that are not approved by AES. This Warranty does not apply to any AES Product or any part thereof that has been altered in any way to affect its stability or reliability, or that has been subjected to abuse, misuse, negligence, accident or act of God, or that has had the serial number effaced or removed.

Certain AES Products are designed to operate and communicate with other specified AES Products and certain other specified products, systems or networks authorized or approved by AES, as identified in the applicable AES Product instructions. This Warranty does not apply to any AES Product that is used with any unauthorized or unapproved products, systems or networks, or that has been installed, applied or used in any manner, other than in strict accordance with AES instructions.

AES makes no warranty, express or implied, other than what is expressly stated in this Warranty. If the law of your state provides that an implied warranty of merchantability, or an implied warranty of fitness for particular purpose, or any other implied warranty, applies to AES, then any such implied warranty is limited to the duration of this Warranty.

AES cannot be aware of and is not responsible for the differing values of any property to be protected by its alarm reporting systems. This Warranty does not cover and AES shall not be liable for any defect, incidental or consequential, loss or damage arising out of the failure of any AES Product to operate.

Some states do not allow the exclusion or limitation of the durations of implied warranties or the limitation on incidental or consequential damages, so the above limitations or exclusions may not apply to you.

This Warranty gives you specific legal rights and you may also have other rights that vary from state to state.

TECHNOLOGY LICENSE:

Certain AES Products include software, protocols and other proprietary and confidential technology and trade secrets of AES which are incorporated in or provided with AES Products solely for use in conjunction with and in order to operate AES Products (“Licensed Technology”). AES grants the original purchaser a non-exclusive license to use such Licensed Technology solely in connection with the use and operation of AES Products and for no other purpose or use whatsoever. No title or ownership in or to any such Licensed Technology is conveyed by the sale or delivery of any AES Products; all such rights are retained by AES.

AES SERVICE PROCEDURE: Contact AES by Phone (978) 535-7310, Fax (978) 535-7313 or Email service@aes-intellinet.com, to receive a Return Material Authorization Number. Have the AES part number and serial number ready. Repack equipment in original or equivalent packaging. Inside the box, please include a contact name, telephone number, address and a brief description of the reason for return.

Ship items freight-prepaid to:

Repair Services, RMA# _____
AES Corporation,
285 Newbury Street
Peabody, MA 01960 USA

(Contact AES for Return Material Authorization number)



August 2016