

AES 7704-DMS Dedicated Monitoring System

Installation, Operation and Programming Manual



AES Corporation

285 Newbury Street

Peabody, MA 01960 USA

Tel (978) 535-7310 • Fax (978) 535-7313

www.aes-corp.com

Copyright © 2025 AES Corp. All Rights Reserved

Table of Contents

| | | |
|-----------|--|-----------|
| 1. | Safety Considerations | 6 |
| 2. | Technical Specifications | 6 |
| 3. | Pre-Installation | 10 |
| 3.1 | Equipment List | 10 |
| 3.2 | Mounting | 10 |
| | Subscriber Location | 10 |
| | Antenna Selection and Location | 10 |
| 3.3 | Requirements | 10 |
| | Environmental | 10 |
| | Electrical Supply | 11 |
| | Wiring Specifications..... | 11 |
| | Power Options | 11 |
| | Battery Size | 11 |
| 4. | Installation..... | 12 |
| 4.1 | Enclosure Installation | 12 |
| | Water Damage Prevention..... | 12 |
| | Mounting the Enclosure..... | 12 |
| 4.2 | Primary Power Wiring..... | 13 |
| | Plug-In Transformer | 13 |
| | Earth Ground Connection | 14 |
| 4.3 | Secondary Power Wiring | 15 |
| | Battery Connection | 15 |
| | Battery Replacement | 15 |
| | Battery Only Restart..... | 15 |
| | Battery Supervision | 15 |
| | Low Battery Voltage Cutoff | 16 |
| | Discharge/Recharge | 16 |
| 5. | External Antenna | 16 |
| 5.1 | Antenna Selection..... | 16 |
| 5.2 | Coaxial Cable and Connector Selection | 16 |
| 5.3 | Antenna Location..... | 16 |
| 5.4 | Antenna Installation | 17 |
| 5.5 | Antenna and Surge Suppressor Grounding | 17 |
| 6. | System Configuration..... | 18 |
| 6.1 | Compatible Device List | 18 |

| | |
|---|-----------|
| Compatible Device Installation and Field Wiring Connections | 18 |
| 6.2 System Configuration Diagram | 18 |
| 6.3 System Communication Configuration | 19 |
| 7. Programming | 22 |
| 7.1 Programming Options (UL Notice to Users) | 22 |
| 7.2 Programming Interface | 24 |
| 7.3 Logging In | 24 |
| 7.4 Configuration Interface..... | 25 |
| Saving Configuration Changes..... | 26 |
| 7.5 View 7704 Subscriber Software Version | 26 |
| 7.6 Change Login Password | 26 |
| 7.7 Subscriber Configuration | 27 |
| Subscriber ID | 27 |
| Event Reporting Route | 27 |
| 7.8 Radio Configuration | 29 |
| 7.9 Central Receiver Configuration..... | 29 |
| 7.10 Advanced Configuration | 30 |
| 7.11 NAC/IDC Configuration | 31 |
| 7.12 Restoral..... | 35 |
| 7.13 Status LED Indicators | 35 |
| 7.14 LCD Front Panel Display System Messages..... | 36 |
| Display Operation | 36 |
| System Status Display and 7704 Version Number | 36 |
| Unit ID and Serial Number | 37 |
| Link Layer and NetCon | 37 |
| Route Table | 38 |
| Zone Configuration | 38 |
| Indication of Alarm Type Present..... | 39 |
| Network Connectivity Status | 39 |
| Battery and AC Power Status | 39 |
| Ground Fault and Battery Charger Status..... | 39 |
| 7.15 Off-Normal Operation..... | 39 |
| Fault Display..... | 40 |
| 7.16 Subscriber Status Check..... | 41 |
| General..... | 41 |
| Routing Table | 41 |

- Hardware41
- 7.17 Tools 42
 - Text Message42
 - Alarm History42
 - RF Traffic42
 - IP Traffic43
 - RF Antenna Test43
 - Ping43
 - System Activity Log43
- 7.18 IP Configuration43
 - IP Address – DHCP.....43
 - IP Address – Static.....43
- 7.19 Silencing/Resetting Events of Zones43
- 8. Notification Appliance Circuits..... 44**
- 9. System Settings 45**
 - 9.1 Product License.....45
 - 9.2 Change Password.....45
 - 9.3 Add User45
 - 9.4 Uploading/Downloading Settings45
 - Download Current Settings46
 - Upload Preconfigured Settings46
 - Reset to Default Configuration46
 - 9.5 System Firmware Update46
 - Upgrading.....46
 - Download Support Files46
 - Restart System46
- 10. Flexible Power Options 46**
- 11. Reporting..... 47**
 - 11.1 AES Mesh Network47
 - 11.2 Compatible Receiver.....48
- 12. Testing 48**
- 13. Maintenance..... 48**
- 14. Troubleshooting 48**
- 15. Repair Information 48**
- 16. Battery Replacement Instructions..... 49**
- 17. AES Model 7740 Annunciator Installation Instructions 49**

17.1 Out of the Box.....49

17.2 Installation Instructions49

18. AES Corp. Contact Information 50

19. Warranty 51

Appendix A. Supported NACs (Compatibility) 52

Appendix B. Supported Smoke Detectors 53

Appendix C. Battery Calculator 54

List of Tables

Table 1. Battery Size Requirements.....11

Table 2. Limitations in Programming Features and Options22

Table 3. CID Event Reporting33

Table 4. System Status LED Indicators35

Table 5. ALM LED Blink Patterns.....36

Table 6. Zone Configuration Options and Display Shorthand.....38

Table 7. Active Events—LCD Displays39

Table 8. Faults and Alarms with Off-Normal Operation40

List of Figures

Figure 1. 7704 NAC board wiring diagram8

Figure 2. Supplying the Subscriber with power (three options)11

Figure 3. DMS wall mounting – hole location and sizes.....12

Figure 4. Removing the NAC/IDC board.....13

Figure 5. Wire separation (non-power limited and power limited).....14

Figure 6. Earth ground connection15

Figure 7. Connecting the backup battery.....15

Figure 8. Antenna and surge suppressor grounding.....17

Figure 9. 7740 Remote Annunciator (the ON side switch position)18

Figure 10. Sole path (single reporting).....19

Figure 11. Single reporting backup19

Figure 12. Dual reporting20

Figure 13. Field wire connections – 7704 DMS21

Figure 14. Silence/reset switch inside enclosure44

Figure 15. Class B NAC wiring.....45

Figure 16. 7740 wiring diagram50

Figure 17. 7740 wire Inputs50

1. Safety Considerations

Warning! Subscriber antenna or other cables that come in contact with electrical power lines may result in **DEATH** or **SERIOUS INJURY**.

Warning! Do **NOT** install the Subscriber unit or antenna during a lightning storm.

- Equipment must be installed in accordance with National Electric Code, NFPA 70, NFPA 72, local building codes, and any specific requirements of the Authority Having Jurisdiction (AHJ).
- Ground the antenna, the 7704 Dedicated Monitoring System (DMS) enclosure, and any surge protector devices to help dissipate surges away from equipment and personnel. Antenna grounding and surge protectors should not be neglected; they are there for your safety and the safety of your equipment.
- Periodically test the system for proper operation. AES assumes no responsibility for the equipment’s failure to operate. AES’s sole responsibility is to repair or replace any AES device found to be defective during the warranty period.
- Exposing DMS electronics to water or moisture environments, such as rain, shower, bath, pool, sauna, etc., can cause damage and unexpected operation.
- Avoid dropping or exposing the unit to physical impact that could damage the enclosure or internal components.
- Equipment used with the IP path must be installed according to NFPA 72 and must be listed to either UL 60950-1 Information Technology Equipment (ITE) – Safety, or to UL Fire.
- ITE equipment requires backup/secondary power such as a building generator backup, UPS, or other power supply with battery backup.

2. Technical Specifications

| Power Supply | |
|---|--|
| Source | Requirements |
| External Class 2 AC Transformer and Rechargeable Backup Battery in 7704 | Transformer Voltage/Frequency: 120 V AC 60 Hz Input Current: 2.3 A max. current (50 VA min.) Input Voltage: 16.5 V AC 12 V DC – Sealed Lead Acid (SLA) – 12 Ah – See Table 1– Battery Size Requirements for details. |

NOTE: The installer is responsible for providing a sealed lead acid battery with amp hour sizing to meet the requirements of the installation as described in this installation manual. The battery must be a UL Recognized Component



Note: All circuits are power limited except for battery leads.

Current Consumption

7704 – Standby w/o backup battery: 400 mA (1.2 A Transmitting)

7704 – Standby w/ charged backup battery: 400 mA (1.2 A Transmitting)

7704 – Standby + charging backup battery: 1050 mA (1.3 A Transmitting – Maximum)

Environmental Specifications

Operating Temperature: 32°F to 120°F (0°C to 49°C)

Storage Temperature: 14°F to 140°F (-10°C to 60°C)

Relative Humidity: 0 to 93% RHC, non-condensing

Mechanical Specifications

Dimensions: 13 in. H × 10 in. W × 4 ½ in. D (33 cm × 25.4 cm × 11.4 cm)

Weight: 8.1 pounds (3.7 kilograms) without battery

16.3 pounds (7.4 kilograms) with 12 Ah battery (battery adds 8.2 lbs.)

Enclosure material: Steel with paint finish

Finish color: Red

Inputs

Alarm Signal Inputs

6 each – Conventional inputs

All inputs are suitable for automatic, manual, waterflow, and sprinkler supervisory service. Inputs are limited to class B.

Fully programable and support two-wire smoke detectors.

Input Wiring Specifications

- Maximum short circuit current = 30 mA
- Maximum wiring resistance = 100 ohms
- Maximum wiring capacitance = 1 μF
- Maximum wire length in feet = 100/ohm per 1 foot of wire
- Operating voltage = 16.5-24.0 VDC

Note: End of resistor is required to 4.7 k per ¼ Watts (02-0054).

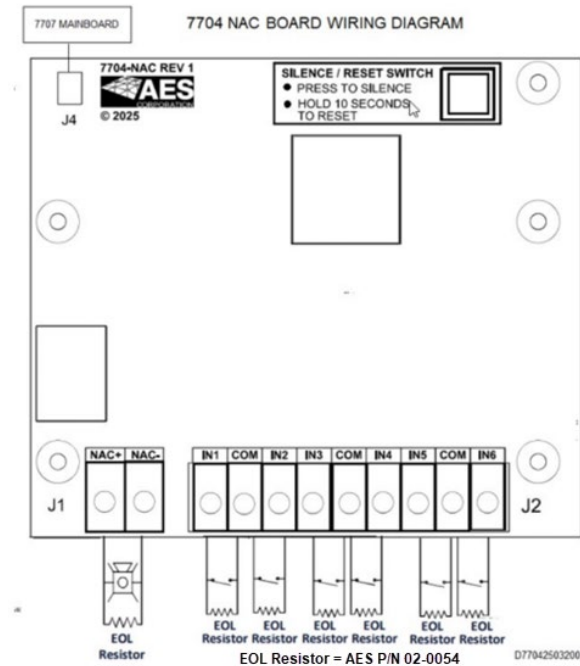

Figure 1. 7704 NAC board wiring diagram

Outputs

There is one NAC circuit provided as a continuous 0.5 amp at 24 V DC. The NAC circuit is class B.

NAC Wiring Characteristics

- Output is supervised and regulated and special application.
 - The regulated NAC shall be rated 1/10th the special application NAC.
- Circuit is power limited.
- Normal standby supervisory current is 2 mA.

Note: This product supports Gentex and System Sensor protocols. Please refer to [NACs specific to manufacturers Potter/Gentex and System Sensor.](#)

End of resistor is required to be 4.7 kilohms, ¼ Watts (AES Part # 02-0054).

NAC Wiring Configuration

Please see the 7704 NAC board wiring diagram ([Figure 1](#)).

Reporting

AC failure (low primary AC voltage limit: 96 V AC)

Low battery (low battery voltage limit: 11.6 V DC)

IDC input ground fault (impedance to earth ground is less than 50 kilohms)

NAC supervision failure (detects shorts and opens)

Battery charger failure

Input module fault

Transceiver

Output power: 2 Watts

Frequency range: 450–470 MHz standard (Contact AES for other frequency bands.)

Signaling Type

1-way RF type 6

Conduit Knockouts

Trade (nominal) sizes:

1/2 — two each

3/4 — two each

3. Pre-Installation

3.1 Equipment List

The following materials are available out of the box:

- Enclosure with key lock and two keys
- 7707 Main Circuit Board
- 7085UE5 2-Watt Transceiver set to authorized frequency
- 7214 Case Top Flexible Tamper Resistant Antenna with cable assembly
- 7704-NAC Circuit Board
- 40-7704-QSG Model 7704 Quick Start Guide
- 02-0054 4.7 kilohm EOL resistors (quantity is seven)

3.2 Mounting

Subscriber Location

Important! A fire alarm installation that complies with UL 864 using the 7704 must be located where a NetCon of 5 is present. Refer to [Link Layer and NetCon](#) for additional details on how to view NetCon. It is important to verify that a location is suitable before deciding on the antenna used and mounting the DMS. A check of the location can be done with the AES Network Connectivity Tool (NCT). The AES NCT provides a quick means for verifying NetCon or finding suitable locations for DMS installation.

Antenna Selection and Location

The Case Top Flex Tamper Resistant Antenna is part of the standard package for the 7704 and mounts on top of the steel cabinet.

Depending on cabinet mounting, Subscriber's physical location, and mesh network connectivity, a remote mount antenna may be required.

A separately purchased remote antenna may be used with the 7704 unit in UL installations. See [External Antenna](#) on page 16 for information on antennas available from AES. The frequency range is 450–470 MHz. Contact the factory at (800) 237-6387 or info@aes-corp.com for other frequencies.

3.3 Requirements

Environmental

Select an installation location that meets the Environmental Specifications described in the [Technical Specifications](#) section on page 6.

Exposing the Subscriber to temperatures below 32°F (0°C) or above 122°F (49°C) can damage the backup sealed lead acid battery. Exposure to extreme temperatures can cause unexpected operation of the Subscriber electronics.

Exposing the Subscriber electronics to water or moisture environments (rain, shower, bath, pool, sauna, etc.) can cause damage and unexpected operation.

Electrical Supply

For power supplied to the DMS from an outlet, connect to an outlet on a dedicated branch circuit that is *not* controlled by a switch. Refer to the [Power Options](#) section below.

Wiring Specifications

The plug-in transformer must be placed in Transformer Enclosure AES P/N 1640-ENCL (available separately).

The wiring from the low-voltage output of the plug-in transformer enclosure to the DMS enclosure must be enclosed in conduit.

Power Options

The following diagram shows three options to supply the Subscriber with power. The [Flexible Power](#) section on page 46 provides instructions on how to configure the Subscriber software for the power option used.

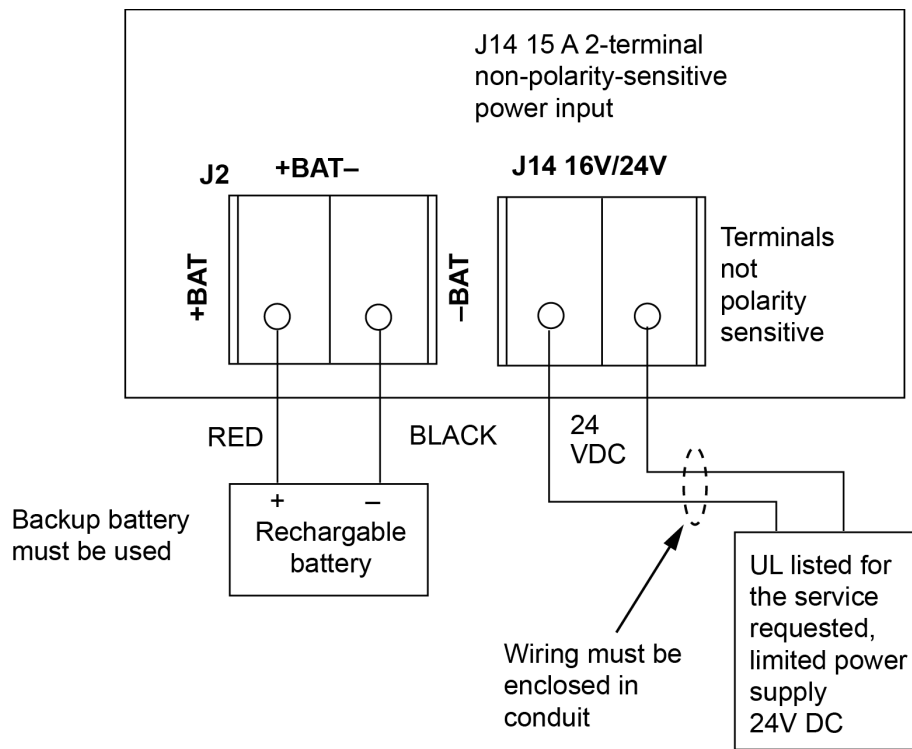

Figure 2. Supplying the Subscriber with power

Battery Size

Battery size requirements are listed in the following table:

| Table 1. Battery Size Requirements | | |
|------------------------------------|---|---------------------|
| System Configuration Description | Current (mA) | Battery Size (12 V) |
| 7704 (6 IDC input card) | See Current Consumption under Technical Specifications on page 6. | 12 Ah |

4. Installation

Warning! Do NOT install the Subscriber unit during a lightning storm.

4.1 Enclosure Installation

Water Damage Prevention

To prevent water damage, take the following precautions when mounting the unit:

- Avoid mounting directly on exterior walls, especially masonry walls (condensation).
- Avoid mounting directly on exterior walls below grade (condensation).

Important! Protect the unit from plumbing leaks AND from splash caused by sprinkler system inspection ports.

- Avoid mounting in areas with humidity-generating equipment (such as dryers or production machinery).

Important! Route conduit to prevent moisture in the conduit from entering the DMS.

Mounting the Enclosure

Check the [Environmental Requirements](#) on page 10 before starting. Mount in an area that is secure, as well as accessible for service and testing. When mounting on an interior wall, use anchors and fasteners appropriate for the wall material and total weight of Subscriber and battery.

When mounting on a concrete wall, the unit must be placed to prevent moisture or water from entering the enclosure. Use standoff material attached to the concrete surface to mount the enclosure. Two key holes and two circular mounting holes are available. Refer to the diagram below for location and sizes of mounting hole.

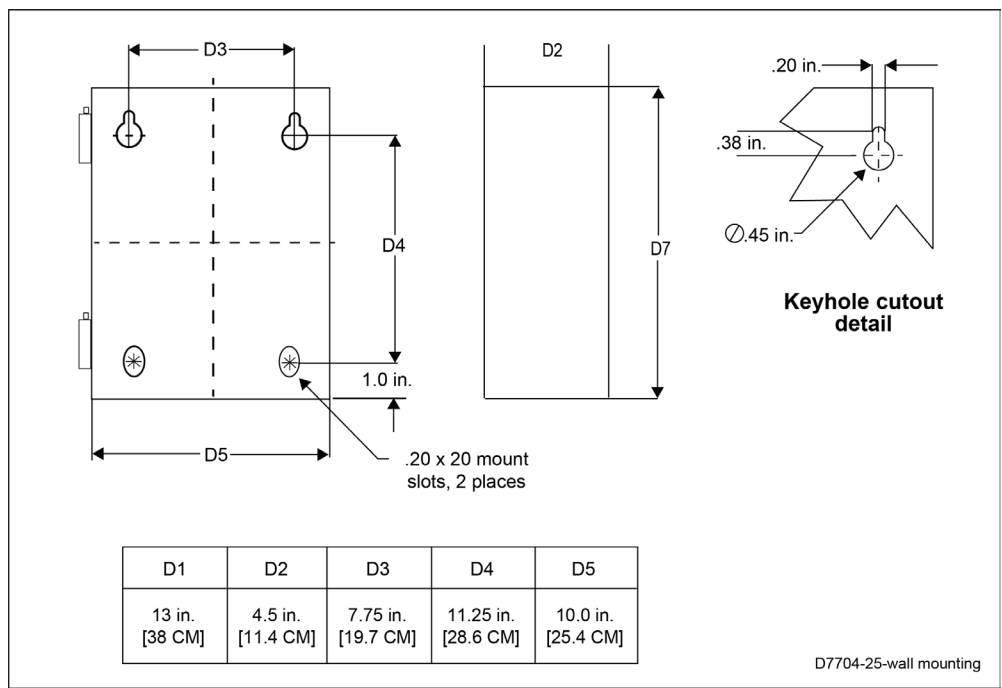

Figure 3. DMS wall mounting – hole location and sizes

Important! Use knockout plugs to close any unused conduit holes in the enclosure.

Removing the NAC/IDC Board

1. Remove the screws that are holding the board to the standoffs
2. Grasp the board at each end by the standoff and pull straight upward to unseat the card from the socket connector on the Subscriber mainboard.

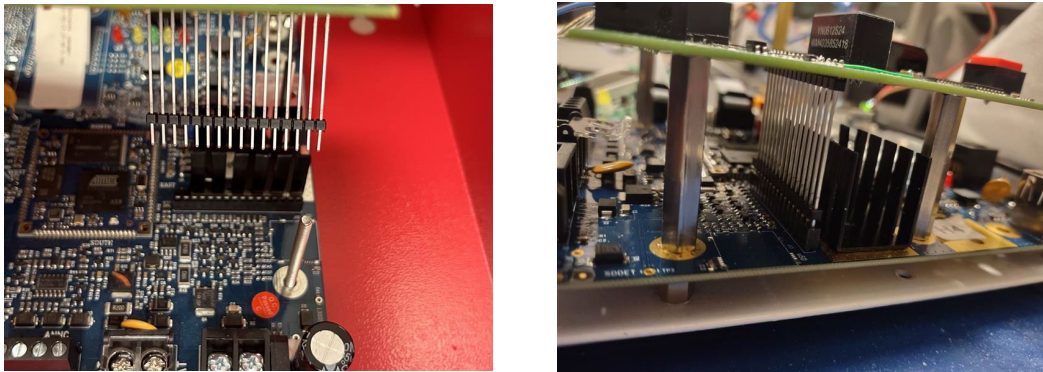

Figure 4. Removing the NAC/IDC board

3. Remove the hex screws.

Removing the Mainboard

1. With all mounted boards removed from the top of the mainboard, remove the remaining hex nuts or standoffs holding the mainboard to the enclosure.
2. Grasp the board on each side and pull straight upward to lift the card off the mainboard support standoffs attached to the enclosure.

4.2 Primary Power Wiring

Plug-In Transformer

Warning! Turn off or disconnect all power before attempting to connect the 7704. Do **NOT** apply power until all accessories are properly connected.

For U.S. installations, use only the Class 2 direct plug-in transformer listed below:

| Manufacturer | Model | Rating |
|---------------------|---------|------------------|
| MG Electronic Sales | MGT1650 | 16.5 V AC, 50 VA |

Important! All installations using plug-in transformers must use the AES Model 1640-ENCL Transformer Enclosure for mechanical protection of the transformer. Wiring from the transformer to the Subscriber must be protected in conduit.

Refer to the wiring diagram for connection details, as well as for routing the battery, enclosure mounted antenna, and the transceiver control cable. Leave a minimum of ¼ inch of spacing between non-power limited (battery wiring) and power limited wiring as shown in the photo below and in [Figure 6. Earth ground connection](#).

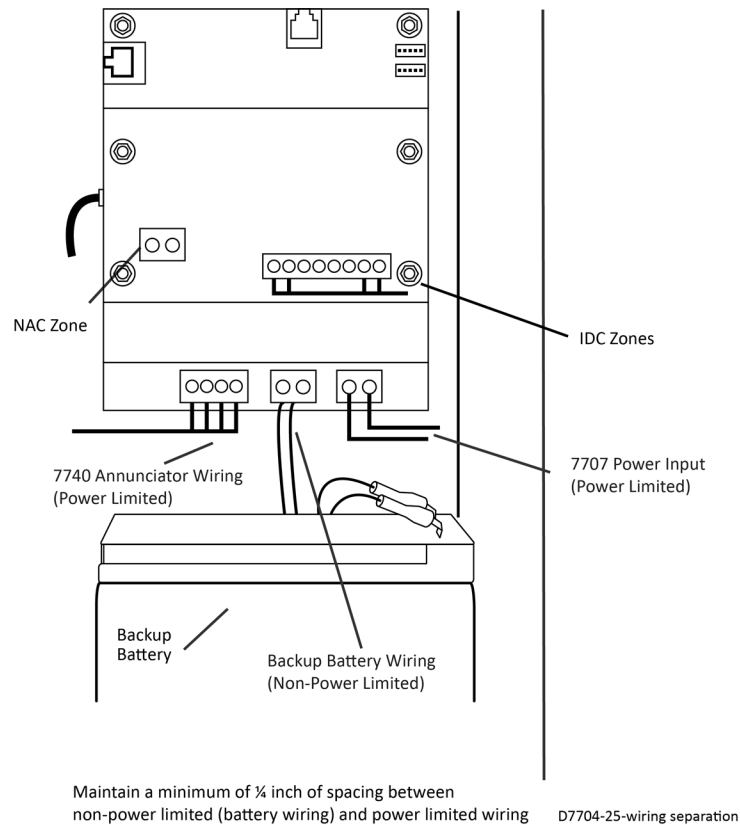

Figure 5. Wire separation (non-power limited and power limited)

Earth Ground Connection

Earth ground and battery minus (–) are not separate connections in 7704. IDC input terminals, including the "COM" terminals on IDC input cards, are isolated from earth ground. Connect a suitable gauge wire as specified in the applicable electrical code to the #8 ground stud as shown in the diagram below. Connect the wire to a suitable earth ground, which includes building steel, buried metallic cold-water pipe, driven grounding rod, and other electrical code approved grounding systems. Electrical noise present on the ground wire from an electrical panel may make it unsuitable for use. Testing of an electrical panel ground source may need to be conducted by a trained electrical technician.

Use a ring terminal to connect the ground wire to the ground stud on the enclosure back box. Assemble the connection as shown in the diagram below. Scrape paint from beneath the ring lug to ensure good metal contact.

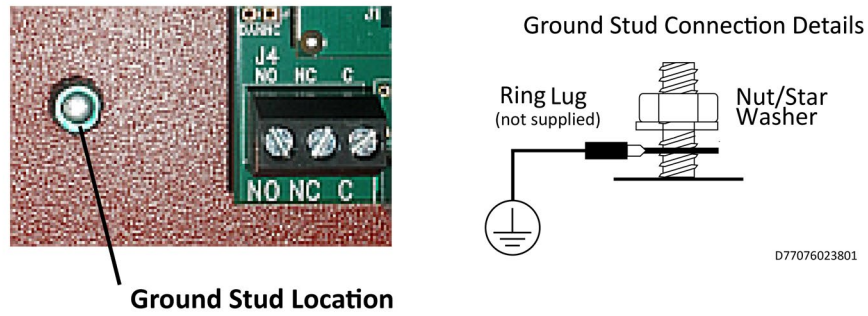

Figure 6. Earth ground connection

4.3 Secondary Power Wiring

Battery Connection

Place the battery in the Subscriber enclosure with the battery quick-connect terminals located to the right side of the enclosure (refer to [Figure 2, Wire Separation - Non-Power Limited and Power Limited Circuits](#) on page 14).

The following steps explain how to connect the backup battery (see diagram also).

1. Connect the BLACK wire from J2 to the negative (-) side of the battery.
2. Connect the RED wire from J2 to the positive (+) side of the battery.

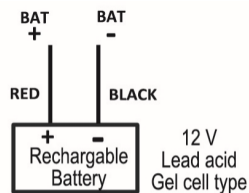

D77076050101

Figure 7. Connecting the backup battery

Battery Replacement

The battery should be replaced every 3 years or when testing indicates replacement is required. Replace with the same size and type installed. See [Battery Replacement Instructions](#) on page 49 for details.

Battery Only Restart

The 7704 without AC power (for test or diagnostic purposes) will power up and self-test with only the battery connected.

Battery Supervision

When AC power is present, the battery is tested at approximately 30-second intervals.

When the battery voltage is below 11.6 V DC for two consecutive test intervals (approximately 60 seconds total time), a low-battery trouble message is transmitted.

When AC power is present and a low battery reaches a charge voltage above 12 V DC, a restoral message is transmitted.

Replacing a low-charge battery with a fully charged battery may result in the DMS not immediately detecting the charged battery. Due to the test cycle time, up to 60 seconds can pass before the fully charged battery is recognized.

Low Battery Voltage Cutoff

To prevent deep battery discharge damage, the 7704 disconnects the battery when voltage is less than 10 V DC.

Discharge/Recharge

The 7704 float charges the battery using a 50 VA transformer. The battery voltage level conditions are:

- Low battery (trouble message): Below 11.6 V DC
- Subscriber battery disconnect: Below 10 V DC
- Battery reconnect (restoral message): Above 12 V DC

5. External Antenna

5.1 Antenna Selection

A remotely mounted external antenna may be required for optimal performance on the mesh network, depending on installation location requirements or conditions. Contact AES Corporation for additional antennas that may be used with the 7704.

5.2 Coaxial Cable and Connector Selection

- Use 50-ohm impedance coaxial cable only. RG-8, 9913, LMR-400, and LMR-600 or equivalent are acceptable coaxial cables. RG-58 may be used for installations where cable is not more than 25 feet long.
- Always use the shortest possible length of coaxial cable. Long lengths of coaxial cable result in greater transmitted signal loss.
- Always use the most direct routing in any coaxial cable installation. Unnecessary and tight bends add to transmitted signal loss.
- Use the proper coaxial connectors and crimp tool for the cable selected. Incorrect or poorly installed connectors can cause transmitted signal power loss.

5.3 Antenna Location

When selecting an antenna location, keep the following in mind:

- The supplied antenna mounts on top of the enclosure.
- Remotely located antennas should be mounted as high as possible, either on top of or inside the building structure. Rooftops and attic spaces are preferable.
- The antenna needs to be high enough to overcome nearby obstructions to the RF signal path.
- A remote antenna should be mounted in a location near the transceiver to minimize coaxial cable signal loss. Do not use cable longer than needed to reach the antenna.
- Avoid installing the antenna close to metal surfaces. Nearby metal may degrade radio communications through signal reflections or antenna detuning.

- Remember that pipes, conduit, wiring, ductwork, and other metal commonly installed within building walls can affect antenna performance.
 - Take into account foil-backed insulation and wallpaper.
 - Metal objects can also be located in adjacent rooms or above ceilings.
 - Metallic framing and supports are commonly used in buildings. Do not mount the antenna directly over, or close to, metal studding, beams, or other supports that can interfere with the RF signal.

5.4 Antenna Installation

Warning! Do **NOT** install Subscriber or antenna during a lightning storm.

The following installation guidelines must be followed when installing the antenna:

- The remotely mounted antenna must be properly grounded to help reduce surge damage from lightning.
- Grounding must be done in accordance with local building codes and in accordance with other requirements from the Authority Having Jurisdiction (AHJ).
- Mount the remote antenna vertically.
- Do not coil or bunch coaxial cable.
- Install the remote antenna in accordance with the National Electric Code and local electric code.

5.5 Antenna and Surge Suppressor Grounding

A protective surge suppressor (AES Model 7230) must be installed in line with any type of remotely installed antenna outside a building as shown in the diagram below. The surge suppressor and remote antenna must be earth-grounded. For U.S. installation, check the National Electrical Code (NEC), state, or local electrical code requirements.

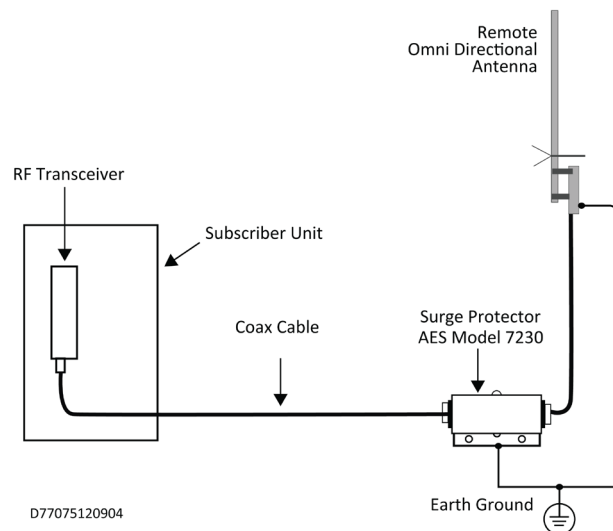

Figure 8. Antenna and surge suppressor grounding

6. System Configuration

6.1 Compatible Device List

Compatible Device Installation and Field Wiring Connections

7740 Remote Annunciator: Refer to page 60 49of this document [AES Model 7740 Annunciator Installation Instructions](#).

Important! When **no** 7740 Remote Annunciator is installed, set DIPSW1 to “**ON**”. The **ON** side switch position is shown in the photo below.

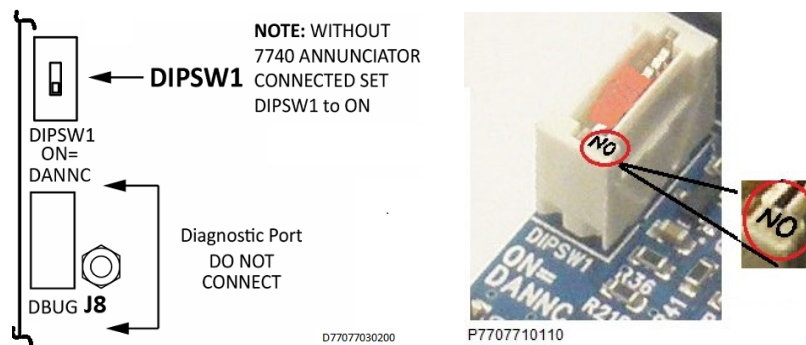

Figure 9. 7740 Remote annunciator (the ON side switch position)

6.2 System Configuration Diagram

| Model | Description | Local | Remote/Central Station | Proprietary |
|---------|----------------------|-------|------------------------|-------------|
| 7704 | Main Board | Y | Y | Y |
| 7740 | Local Annunciator | O | O | O |
| 02-0054 | End of line resistor | Y | Y | Y |

Y = Yes, required for application section
 O = Optional, may or may not be used, has no effect on application section

6.3 System Communication Configuration

Sole Path (Single Reporting) utilizes either the AES mesh radio network or a TCP/IP broadband connection to deliver messages from the Subscriber to the central monitoring station.

As the references below indicate, 7705ii and INCC 8705 can be used in the following configurations:

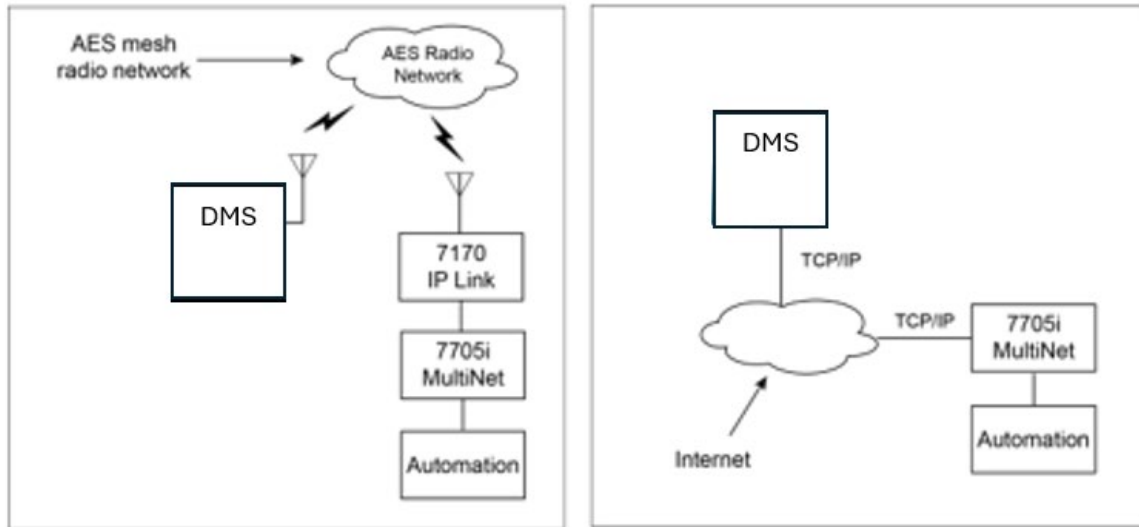

Figure 10. Sole path (single reporting)

Single Reporting with Backup utilizes either the AES mesh radio network, or a TCP/IP broadband connection, to deliver messages from the Subscriber to the central monitoring station. The **Backup Reporting** path works when the **Primary Reporting** path is down.

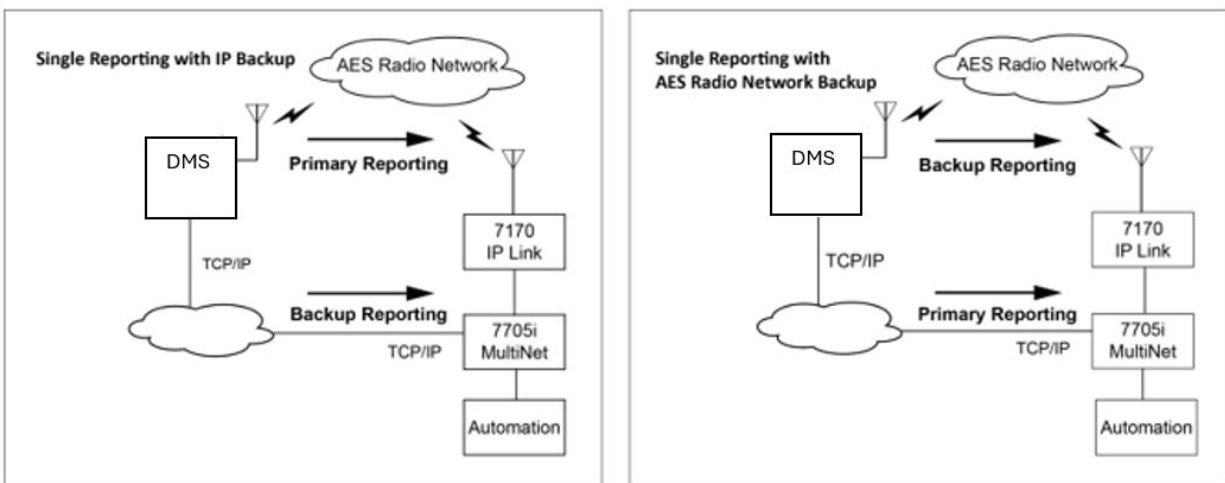

Figure 11. Single reporting backup

Dual Reporting utilizes both the AES mesh radio network and the TCP/IP broadband connection. Messages from the Subscriber to the central monitoring station are launched on both paths together.

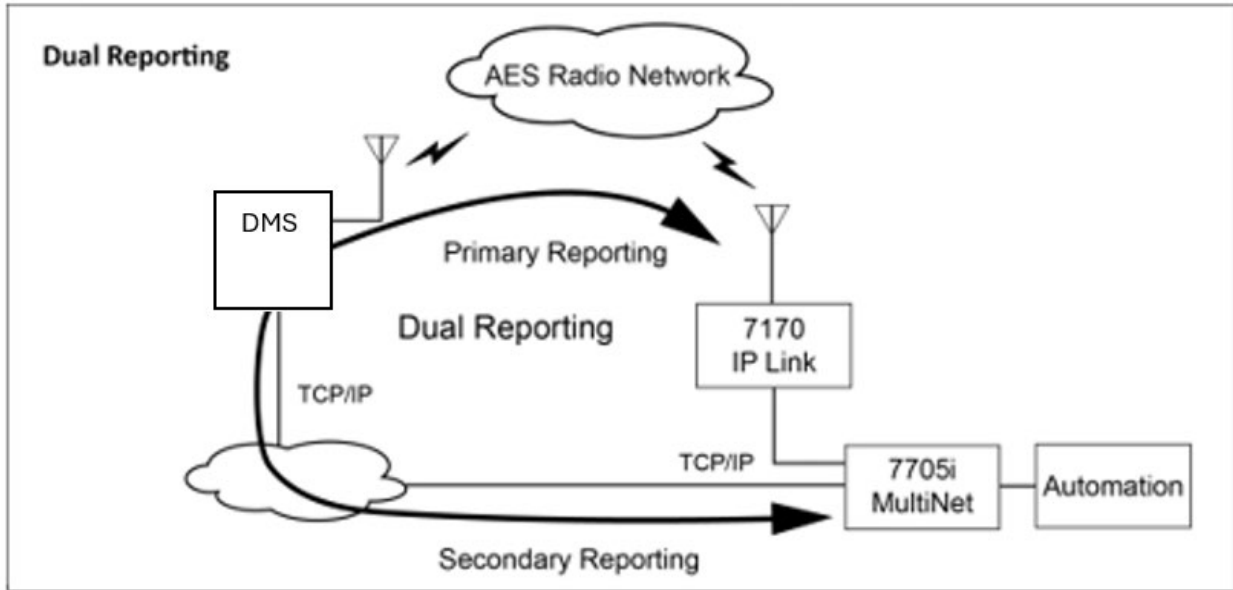

Figure 12. Dual reporting

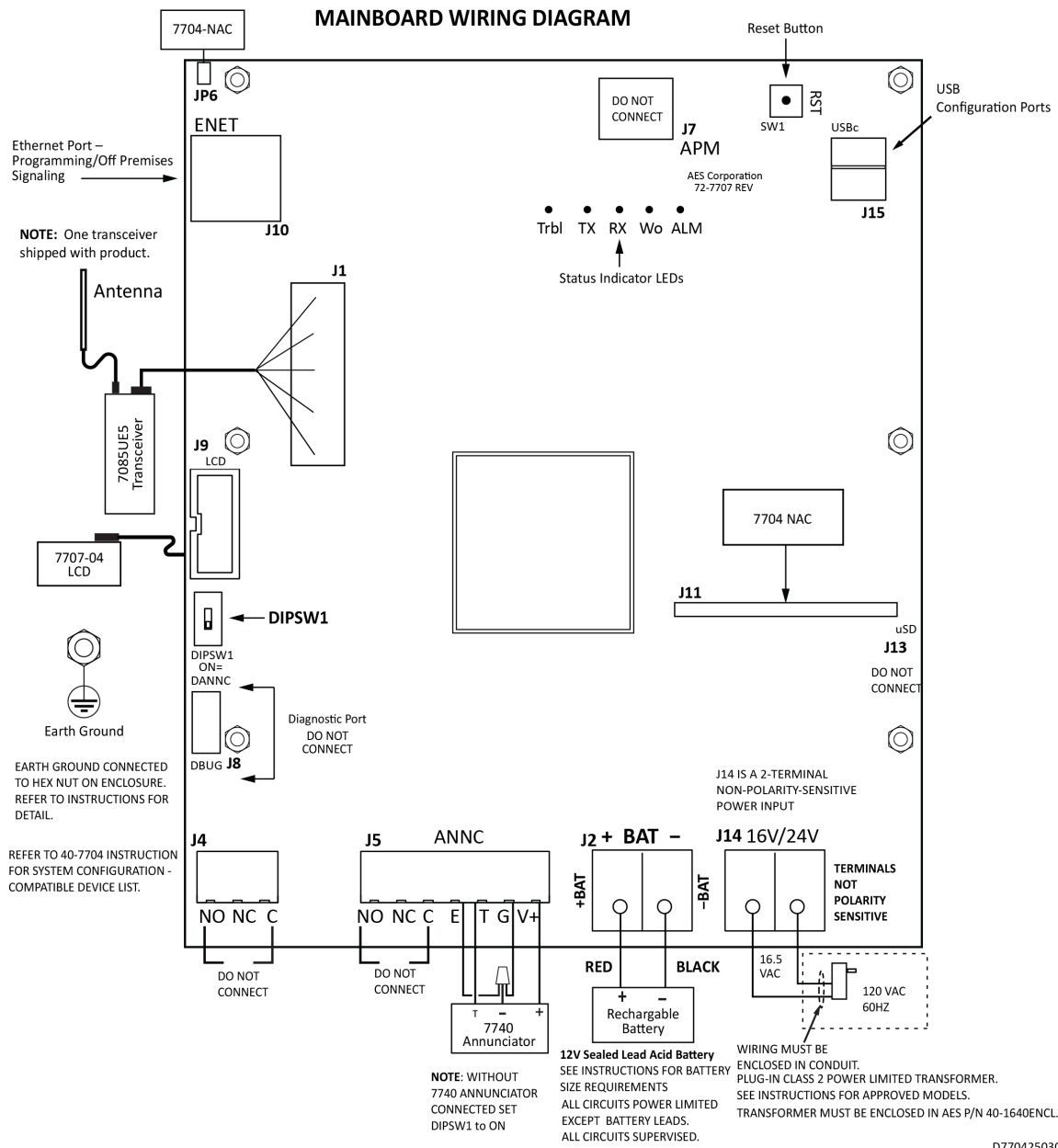

Figure 13. Field wire connections – 7704 DMS

7. Programming

7.1 Programming Options (UL Notice to Users)

NOTICE TO USERS, INSTALLERS, AUTHORITIES HAVING JURISDICTION, AND OTHER INVOLVED PARTIES

This product incorporates field-programmable software. In order for the product to comply with the requirements in the Standard for Control Units and Accessories for Fire Alarm Systems, UL 864, certain programming features or options must be limited to specific values or not used at all as indicated below.

| Table 2. Limitations in Programming Features and Options | | | | | |
|---|--------------------------|----------------------------|--|---------------------------------------|---|
| Topic | Feature or Option | Permitted in UL 864 | Possible Settings | Setting(s) Permitted in UL 864 | Comment |
| Radio Configuration | Secondary Alarm Delay | Y | 1–330 seconds | 1–10 seconds | |
| | Check-in Time | Y | 0–24 hours | 0–24 hours | |
| | Inet Check-In | Y | 0-6 hours | 0-6 hours | Not required if RF is configured |
| | Communication Timeout | Y | 1–300 seconds | UL: 1–120 sec ULC: 1-60 sec | |
| | Repeating | Y | Y or N | Y | |
| Event Reporting | Reporting Route | Y | Radio Only, Internet Only, Radio & Internet, Radio with Internet Back Up, Internet with Radio Back Up | N/A | |
| Zone | Latching | Y | Yes/No | Y | |
| Zone | Output Pattern | Y | Constant, Temporal 3, March Code, Double Time | | |
| Input Points: Dry Contact Input Functions | Zone Programming | Y | Waterflow, Pull Station, Tamper, Fire Drill, Trouble, | Y | Applies to all input points and circuits |

| Table 2. Limitations in Programming Features and Options | | | | | |
|--|--|---------------------|--|--|--|
| Topic | Feature or Option | Permitted in UL 864 | Possible Settings | Setting(s) Permitted in UL 864 | Comment |
| | | | AUX, Bypass, Heat, Smoke | | |
| Input Point | Supervisory | Y | Yes/No | Y | |
| NAC | Function | Y | Gentex, System Sensor | Y | Specifies use of NAC circuit |
| Power Options | 24 V DC Regulated Power Supply with Backup Battery | Y | 24 V DC and Battery | Y | UL Listed for Fire Service Regulated Power Supply 24 V DC Rechargeable backup battery in Subscriber. |
| System | AC Fail/DC Fail Report Delay | Y | 0–60, or R (0–60 minutes, or random time between 0–60 min.) | 0-60 (minutes) R (random time from 0–60 minutes) | |
| | Locally Announce AC Fault/DC Fault | Y | Y or N | Y | |
| | Suppress AC Fault/DC Fault | N | Y or N | N | |
| | Suppress Charger Fault | N | Y or N | N | |
| | Suppress Battery Fault | N | Y or N | N | |
| Advanced Configuration | Suppress Ground Fault Reporting | N | Y or N | N | |
| Central Receiver Configuration | Inet Check-In | Y | 1 minute to 24 hours | 6 hours maximum | |
| | MCT Timeout | Y | 0 to 120 seconds | 10 seconds maximum | |

Important! UL and NFPA standards do not allow remote programming of an installed 7704 unless an authorized person is present at the unit to enable temporary remote programming capability. **Note:** When any zone is configured as **Fire**, remote programming can be performed only up to 10 minutes after the Subscriber is reset or powered up.

7.2 Programming Interface

Important! Eliminate false alarms by notifying the central station operator ahead of time *before* the Subscriber is powered on. A false alarm/report and dispatch of services to the *previous* Subscriber location may occur if this is not done.

The Model 7704 is programmed using a graphical interface through a smartphone, a laptop/tablet, or other web browser capable device.

The Subscriber is connected to a LAN through the J10 Ethernet connector. The default network protocol is DHCP. The IP address obtained is shown on the LCD display during Subscriber power-up. An example display is shown below. The actual IP address will depend on the network a Subscriber is connected to.

LAN: 10.0.3.111

Note: If DHCP is not available, the IP address is set to 169.254.100.1.

7.3 Logging In

Connecting to the 7704 configuration page requires a login. Enter the IP address of the Subscriber in the web browser, then enter your username and password at the login screen. The default username and password are admin (lower case):



The following screen appears after a successful login:

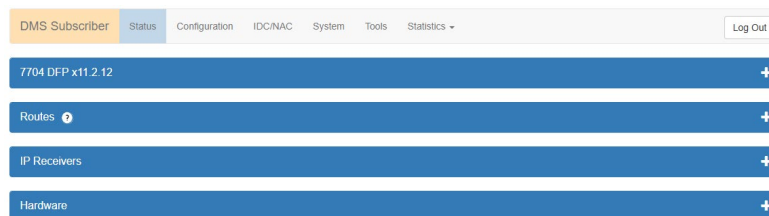

Note: A **Fault Details** control window automatically appears when the Subscriber has fault conditions. The **Fault Details** control window is not present when there are no Subscriber faults.

7.4 Configuration Interface

Navigation

Individual pages are listed in a tab bar:

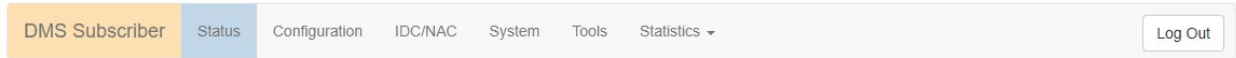

To go to a page, select a tab by clicking on it. For example, the **Tools** page is accessed by pointing and clicking on **Tools**. Each page displays a set of controls as shown below:

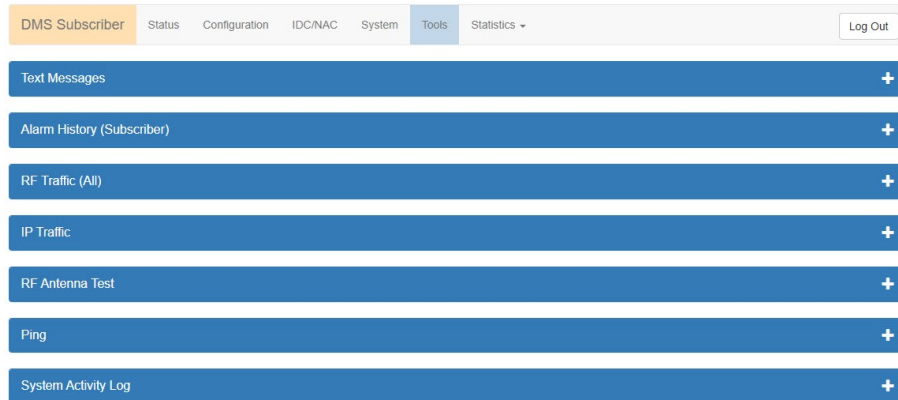

Use the  control to expand the control window. In this example, expanding **Alarm History** allows for viewing messages similar to the example below:

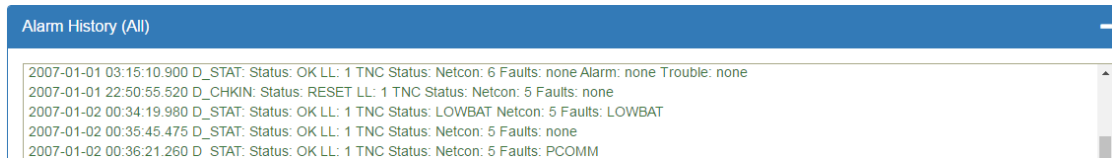

Use the  control to collapse the window. The **Log Out** control ends the configuration session and returns to the login screen.

Making Configuration Changes

Configuration settings are made and changed using either the dropdown or slider switch controls in the window.

The dropdown provides a list to select from:

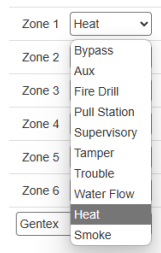

The slider switch provides one of two values to select:



Saving Configuration Changes

Saving configuration changes requires the following steps:

- When you are finished making changes, click the **Save Changes** button. The **Saved new settings!** acknowledgement appears:

Saved new settings! Click "Update" from menu bar to confirm changes.

You may finish and save your changes immediately, or you can make additional changes and then save all changes at once afterward.

- If done making changes, click the **Update** tab, as shown below:

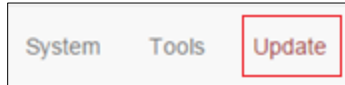

- After the changes are saved, the **Status** window displays, as shown below:

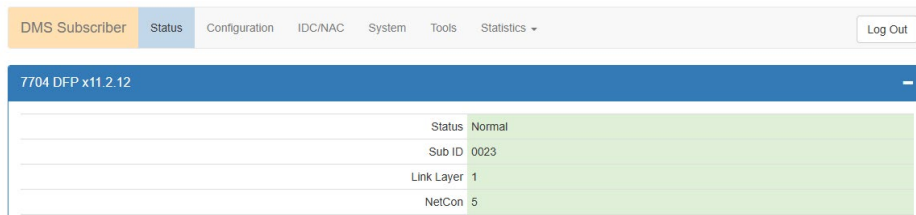

7.5 View 7704 Subscriber Software Version

The 7704 software version is visible in the **System** tab window under **System Firmware Upgrade**.

Select the **System** tab:

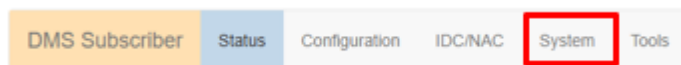

The version number displays in the **System Firmware Update** section.

7.6 Change Login Password

- Select the **System** tab:

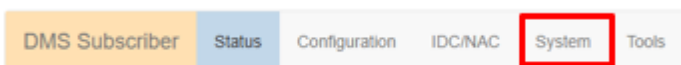

- Place the cursor in the **Current Password** text box, then type the current password.
- In the **New Password** text box, type the new password. Type the new password again into the **Confirm** box and click **Change Password**.

7.7 Subscriber Configuration

Subscriber ID

The Subscriber ID is set in the **Configuration** tab.

1. Select the **Configuration** tab, as shown below:

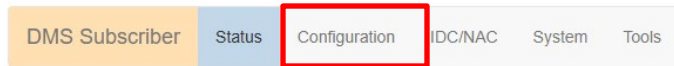

Note: Remote programming of ID and cipher code is not possible. The ID number entered must be unique from any other ID number already in the system.

2. Change the **Sub ID** by entering a four-character hex (0–9 and A–F) identification number. Valid values are 0001 to FFFF.

Important! See [Programming Options \(UL Notice to Users\)](#) which starts on page 22 for software settings permitted for the following parameters.

Event Reporting Route

3. From the main menu, click the **Configuration** tab.
4. In the **Event Reporting** panel click the **Reporting Route** dropdown and select the path for the Subscriber to communicate. Refer to [System Configuration](#) for diagrams showing each Reporting Route selection.

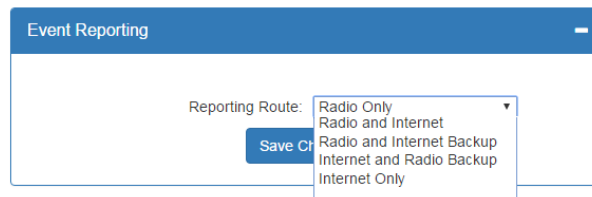

Complete the configuration using the links shown below for the Event Reporting path selected for the Subscriber:

- Radio Only:

- [Radio](#) Configuration (refer also to the AES Mesh Radio Network diagram on page 18)
- Radio and Internet:
 - [Radio](#) Configuration, [Central Receiver Configuration](#) and Subscriber IP Address under [Advanced Configuration](#) (refer also to the Dual Reporting diagram on page 19).
- Radio and Internet Backup:
 - [Radio](#) Configuration, [Central Receiver Configuration](#) and Subscriber IP Address under [Advanced Configuration](#). Refer also to the Single Reporting with Backup diagram on page 18.
- Internet and Radio Backup:
 - [Radio](#) Configuration, [Central Receiver Configuration](#) and Subscriber IP Address under [Advanced Configuration](#). Refer also to the Single Reporting with AES Radio Network Backup diagram on page 18.
- Internet Only:
 - [Central Receiver Configuration](#), and Subscriber IP Address under [Advanced Configuration](#). Refer also to the Internet diagram on page 19.

7.8 Radio Configuration

The Radio Configuration panel contains Subscriber Cipher (dealer code), Check-In, Communication Timeout, and Repeating settings.

To set Radio Configuration:

1. Click the **Configuration** tab.
2. Scroll to the **Radio Configuration** panel.
 - **Cipher:** Enter the four-character hex (0–9 and A–F) cipher code (dealer code) assigned by the system administrator. Valid values are 0000 to FFFF.

Note: The code must match the AES 7170 IP-Link cipher code for the network that the Subscriber is to join. The Subscriber will not join the mesh network if the cipher code is incorrect.

Important! See [Programming Options \(UL Notice to Users\)](#) which starts on page 22 for software settings permitted for the following parameters.

- **Check-In Time:** Enter check-in hours and minutes. The default is 23:45 (23 hours 45 minutes).

Note: Using short check-in times generates more traffic on the network.

- **Communication Timeout:** Communication Timeout is the time the Subscriber waits for an **ACK** as a reply to a transmitted packet or when the Subscriber is at NetCon 7 and is waiting to join the mesh network. The range is 1–300 seconds. The default and maximum time allowed for this option is 120 seconds.
- **Repeating:** Set Repeating to **Enabled/Disabled** by clicking on the **Repeating** switch.

Important! UL-864 compliant Fire Alarm installations require **Repeating** to be set to **Yes**. See the [Programming Options \(UL Notice to Users\)](#) which starts on page 22 for software settings permitted for the following parameter.

7.9 Central Receiver Configuration

The Central Receiver panel contains Internet connection settings to the MultiNet receiver.

Note: Central Receiver Configuration must be set when using IP Reporting.

To set Central Receiver Configuration:

1. Click the **Configuration** tab.
2. Scroll to the **Central Receiver** panel.
 - **IP Group ID:** Enter the assigned ID as found in Business Unit Settings.
 - **Primary Receiver IP:** Enter the Primary Receiver IP address.
 - **Primary Receiver Port:** Enter the Primary Receiver Port number.
 - **Secondary Receiver IP:** Enter the Secondary Receiver IP address.
 - **Secondary Receiver Port:** Enter the Secondary Receiver Port number.

Important! See [Programming Options \(UL Notice to Users\)](#) which starts on page 22 for software settings permitted for the following parameter. (Inet Check-In)

- **Inet Check-In:** Enter the check-in time interval for the Subscriber.
- **MCT Timeout:** Enter the MCT (Multiple Communications Technology) Timeout. The MCT Timeout sets the amount of time the Subscriber tries to send messages though one communication technology before giving up and switching to the other technology.

7.10 Advanced Configuration

From the Advanced Configurations menu, you can configure the ground fault reporting, secondary alarm delay, TTL (time to live), and the Subscriber IP address. To configure these settings:

1. Select the **Configuration** tab.
2. Scroll to the **Advanced Configuration** panel.
 - Suppress Ground Fault Report

Important! UL-864 compliant Fire Alarm installations require **Suppress Ground Fault Reporting** to be set to **No**. See the [Programming Options \(UL Notice to Users\)](#) which starts on page 22 for software settings permitted for the following parameter.

Set **Suppress Ground Fault Report** to **Yes/No** by clicking the Suppress Ground Fault Report switch.

- Secondary Alarm Delay

Enter the number of seconds allowed between data transmissions from the Subscriber. The range is 1–330 seconds. The default and maximum time allowed for this setting is 10 seconds.

Note: The first message is sent immediately without delay. Messages that follow are delayed.

- TTL (Time-To-Live) Configuration

Time-to-Live settings are for managing the performance of the AES mesh network. TTL is the length of time a packet message transmission for a specific setting is retried by a Subscriber in the AES mesh network. The Subscriber will stop attempting to transmit the packet when the TTL limit has expired.

To set Time-to-Live:

3. Scroll to the **Configuration** tab.

- 4. Select the **Advanced Configuration** panel and configure the setting:

| Message Type | TTL |
|--------------|------------|
| CHECK-IN | 10 minutes |
| STATUS | 10 minutes |
| ALARM | 3:00 hours |
| TROUBLE | 3:00 hours |
| RESTORAL | 3:00 hours |
| INTELLIPRO | 3:00 hours |
| SPECIAL | 10 minutes |

- Subscriber IP Address Information

To set Subscriber IP Address

1. Scroll to the **Configuration** tab.
2. Select the **Advanced Configuration** panel and configure the settings:

Subscriber IP Address type: Select **STATIC** or **DHCP**

If **STATIC** address is selected, enter the following information:

IP Address – The IP address of the Subscriber

Subnet Mask

Gateway

DNS Server 1 (Optional)

DNS Server 2 (Optional)

7.11 NAC/IDC Configuration

NAC/IDC are configured under the **IDC/NAC** tab in the browser.

DMS Subscriber | Status | Configuration | IDC/NAC | System | Tools | Statistics | Log Out

DMS

| | | | | | | | | | | |
|--------|--------------|---------|----|----------|-----|-------------|----|----------------|---|------|
| Zone 1 | Water Flow | Use NAC | No | Latching | Yes | AutoSilence | No | Period (1-360) | 1 | Min. |
| Zone 2 | Smoke | Use NAC | No | Latching | Yes | AutoSilence | No | Period (1-360) | 2 | Min. |
| Zone 3 | Pull Station | Use NAC | No | Latching | Yes | AutoSilence | No | Period (1-360) | 3 | Min. |
| Zone 4 | Tamper | Use NAC | No | Latching | Yes | AutoSilence | No | Period (1-360) | 4 | Min. |
| Zone 5 | Heat | Use NAC | No | Latching | Yes | AutoSilence | No | Period (1-360) | 5 | Min. |
| Zone 6 | Supervisory | Use NAC | No | Latching | Yes | AutoSilence | No | Period (1-360) | 6 | Min. |

NAC Sequence: Gentex

Fire Drill Test: Start Stop

Event Report Format: SIA

Save Changes

- **Bypassed** – Zone input is ignored.

| Zone Input Condition | Zone Programming | |
|---------------------------------|------------------|---------------|
| | Fire | Bypass |
| 2.2 kilohm EOL resistor circuit | Normal | Input Ignored |
| Open circuit | Trouble | Input Ignored |
| Short/closed circuit | Alarm | Input Ignored |

| IDC Default Configuration | | USE NAC | LATCHING |
|---------------------------|------------------|---------|----------|
| INPUT ZONE | Default Function | | |
| Input 1 | Water Flow | Y | Y |
| Input 2 | Smoke Detector | Y | Y |
| Input 3 | Manual Pull | Y | Y |
| Input 4 | Supervisory | N | Y |
| Input 5 | Supervisory | N | Y |
| Input 6 | Valve Tamper | Y | Y |

Additional settings for IDC configuration are:

USE NAC: Yes/No

If yes, triggers the NAC to annunciate upon event

Latching: Yes/No

If yes, requires a reset of NAC to silence/reset.

If no, restores upon alarm condition back to normal state.

Auto Silence: Yes/No

If yes, please configure period of time (1-360) minutes. Shall allow the automatic silencing of an alarm signal and or alert after preset configured time.

CID Reporting

| Table 3. CID Event Reporting | | |
|-------------------------------------|------------|------------|
| Input Type | CID | NAC |
| Bypassed | — | N |
| Fire/Aux | 140 | Y/N |
| Fire Drill | None | Y/N |
| Pull Station | 115 | Y/N |
| Supervisory | 200 | Y/N |
| Tamper | 203 | Y/N |
| Trouble | 373 | N |
| Water Flow | 113 | Y/N |
| Heat | 114 | Y/N |
| Smoke | 111 | Y/N |
| Any Input TROUBLE (OPEN) | 373 | N |

SIA Reporting

(If Enabled)

| Input Type | SIA | | |
|--------------------------|------------|-------------------|-----------------|
| | CID | Event Code | Restoral |
| Bypassed | - | - | - |
| Fire/Aux | 140 | UA | UH |
| Fire/Aux Trouble | 140 | UT | UJ |
| Fire Drill | N/A | N/A | N/A |
| Pull Station | 115 | FA | FH |
| Pull Station Trouble | 373 | FT | FJ |
| Supervisory | 200 | SS | SR |
| Tamper | 203 | SS | SR |
| Tamper Trouble | 373 | SS | SR |
| Trouble | 373 | ZT | ZR |
| Water Flow | 113 | SA | SH |
| Water Flow Trouble | 373 | ST | SJ |
| Heat | 114 | KA | KH |
| Heat Trouble | 373 | FT | FJ |
| Smoke | 111 | FT | FJ |
| Smoke Trouble | 373 | FT | FJ |
| Any Input TROUBLE (OPEN) | 373 | ZT | ZJ |

Navigate to following page to toggle between CID/SIA.

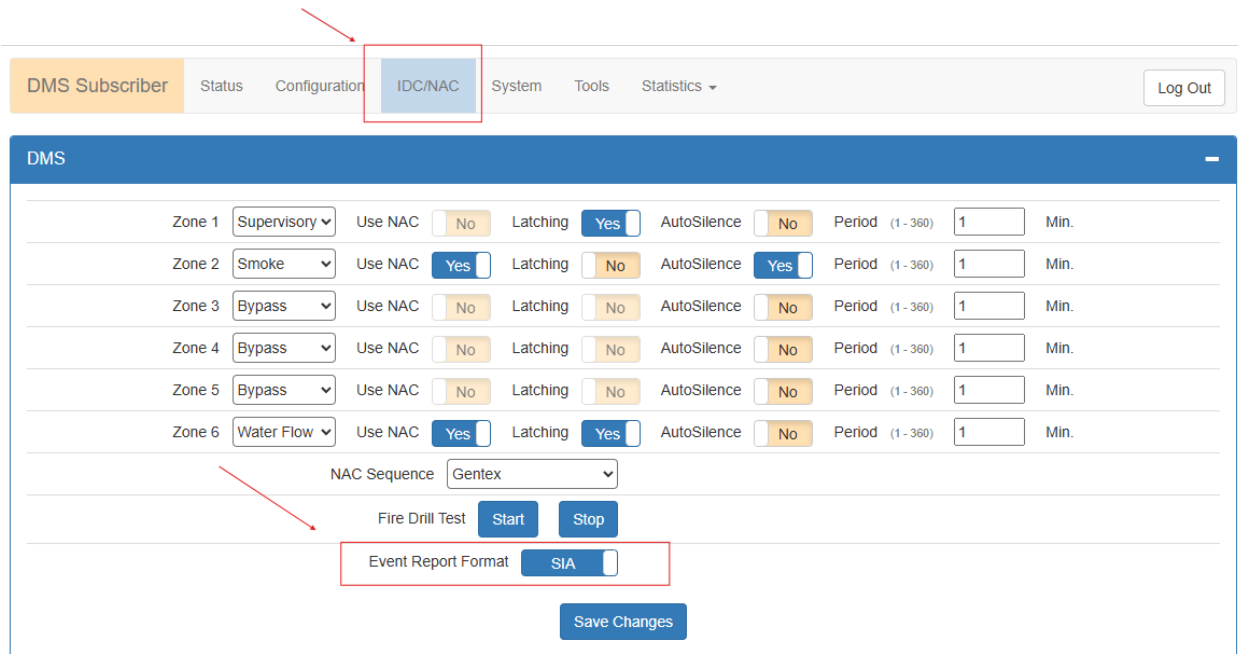

1. Set **Consecutive AT Events** (Consecutive Alarm/Trouble Events) to **Yes** for verbose reporting of alarm and trouble messages. When **Consecutive AT Events** is enabled and an event occurs, an alarm or trouble message will be sent regardless of the number events. One example is the sequence of messages “alarm – trouble – alarm – trouble ...” Set to **No** for non-verbose reporting. When disabled, an alarm and a trouble will be sent once only, even when a zone might be continually changing state multiple times.
2. Select the zone behavior for each zone using the dropdown box.

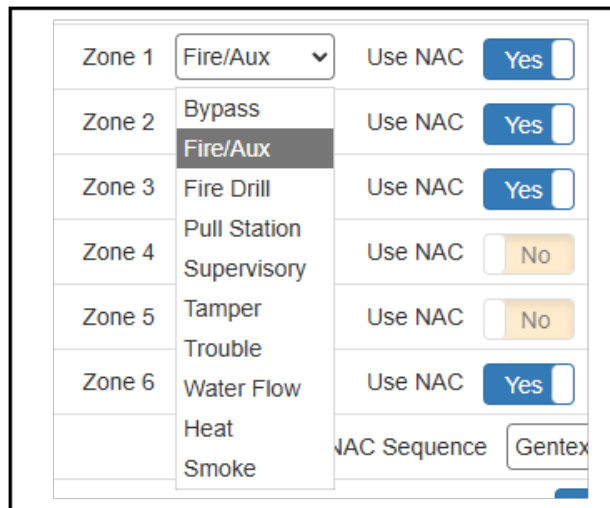

Important! Wiring of any IDC/NAC output to any 7704 zone input/output must use an EOL resistor

supervised zone programmed. Zone inputs Z1 through Z6 meet this requirement.

Note: Set all unused zones to **Bypassed**. Do NOT install EOL resistors on **Bypassed** zones.

Note: Detectors of different models are not to be mixed or matched on 7704 system, unless the system is specifically intended to be installed in that configuration. When mixing is permitted, specific limitations shall be included.

7.12 Restoral

Restoral messages are sent for the zone when Latching switch is set to **No**. When finished with Configuration, save the configuration by clicking **Save Changes**.

7.13 Status LED Indicators

The five LED indicators on the main circuit board of the Model 7704 show system status. The LEDs are located near the top edge of circuit board below the J7/APM connector and near the **RESET** button as shown below:

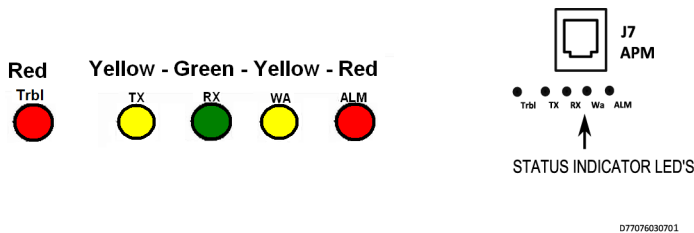

| Table 4. System Status LED Indicators | | |
|---------------------------------------|--------|--|
| LED | Color | Function |
| ALM | Red | Status/troubleshooting indicator, "blink" (see ALM LED Blink Patterns table below) |
| WA | Yellow | Steady On = Waiting for acknowledgment of last transmission Steady Blinking = Not on Network Off = Normal |
| TX | Yellow | On = Radio transmit |
| RX | Green | On = Radio transceiver receiving RF signal Note: If RX is on steady for longer than 20 seconds, an interfering RF signal exists. Any RF signals that are on the same frequency as the Subscriber and which are strong enough to break the squelch will also cause the RX light to remain on. |
| Trbl | Red | Blinking Continuously = Trouble Condition. Refer to Table 8 for trouble details. |

ALM LED Blink Pattern Chart

The chart below shows blink patterns utilized by the ALM LED, as well as possible meanings:

| Table 5. ALM LED Blink Patterns | | |
|---------------------------------|---------------------------|--|
| Blink Type | Pattern | Possible Meaning(s) |
| Steady blink | ■ ■ ■ ... | Normal operation |
| Short-short blink | ■■ ■■ ■■ ... | Low battery |
| Short-long | ■ ■■■ ■ ■■■ ■ ■■■ ... | Zone input in alarm or trouble/off normal |
| Short-short-long | ■■ ■■■ ■ ■■■ ■ ■■■ ... | Low battery and zone in alarm/trouble |
| Short-short-pause-short | ■■ ■ ■ ■ ■ ■ ■ ■ ■ ... | AC Fault |
| Short-short-pause-short-short | ■■ ■■ ■ ■ ■ ■ ■ ■ ■ ■ ... | AC Fault and low battery |
| Steady/no blink | ————— | Self-test failure (excluding low battery and AC) |

Symbols as follows: "■" = short blink, "■■■■" = long blink

The period between patterns is about 1 second (the chart shows each pattern repeating three times).

7.14 LCD Front Panel Display System Messages

Display Operation

The 7704 Subscriber uses a combination LCD display and a **MENU** pushbutton switch to navigate through the system message screens.



Note: Pressing and releasing the **MENU** button allows you to advance in a loop through the display screens until returning the System Status display screen when in Normal mode or scroll through faults when Off-Normal.

System Status Display and 7704 Version Number

When the Model 7704 is operating normally, the Normal System Status screen is shown in the LCD. The model number, software version number, and status message are displayed as shown below:

```
7704  VER: X.XXX
Status: Normal
```

Press the **MENU** button on the front of the enclosure once to advance to the Unit ID and Serial Number status display.

Unit ID and Serial Number

```
ID: B10B
Serial No: B07
```

Note: The Subscriber ID can be *viewed* but *cannot* be set through the System Messages display. Use the configuration web page to change the Subscriber ID.

Link Layer and NetCon

Press the **MENU** button once to advance to the Local Status Check screen, where Subscriber Link Layer and NetCon values are displayed.

```
LINK LAYER: 1
NETCON: 5
```

Press the **MENU** button once to advance to the Routing Table Display screen:

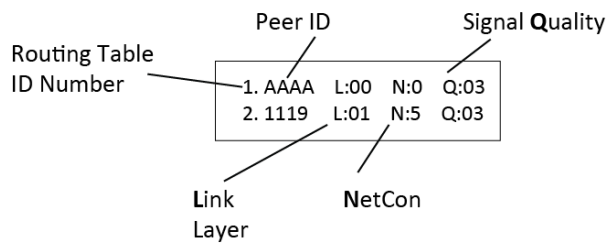

D77076030105

A total of four display screens are available to show the routing table. Up to eight peers, Subscribers, or IP links may be listed in the table. Each screen displays two Subscribers. The total number of display screens will vary depending on the total number of peers listed (a number from 1 to 8). Press the **MENU** button once to advance to the next routing table screen.

- **Routing Table ID#:** A routing table lists up to eight other Subscribers ID numbers or IP links in a table. The purpose of the list is to select a peer for passing off data packets. The table is sorted with the best quality Subscriber placed at preference location 1. Quality is a measure of the neighbor Subscriber's ability to pass data packets.
- **L:** Link Layer as reported by last transmission from the peer ID number shown.

- **N:** NetCon (NETwork CONnectivity) – An internal rating used in the automatic positioning of this unit in the network. A NetCon value of 5 is required for a Subscriber that is compliant with UL-864, 10th Edition.
- **Q:** Signal quality – The first digit is either an 8 or a 0 (zero). The second digit is a measure of how old the data is (a 3 is assigned to the newest data; a 1 is assigned to older data). Routing preference is given to strong, recently heard Subscribers (03) versus weaker Subscribers heard a long time ago (81).

Route Table

```

1.AA1A L:00 N:0 Q:03
2.A21A L:01 N:5 Q:03
```

Press the **MENU** button to view the next status message. Additional routing table screens may appear depending on the number of routes available.

Zone Configuration

The configuration of the six input zones is shown:

```

IN:1-Wat 2-Smo 3-Pul
IN:4-Sup 5-Sup 6-Tam
```

The zone configuration options and display shorthand are listed below:

| Table 6. Zone Configuration Options and Display Shorthand | |
|--|-----|
| Bypassed | Byp |
| Smoke | Smo |
| Heat | Hea |
| Water Flow | Wat |
| Trouble | Tro |
| Tamper | Tam |
| Supervisory | Sup |
| Pull Station | Pul |
| Fire Drill | Fir |
| Fire/Aux | Aux |

Indication of Alarm Type Present

The LCD displays the following on the top line for active events:

Table 7. LCD Displays for Active Events

| | |
|-------------|---------|
| Alarm | ALM [X] |
| Trouble | TRB [X] |
| Supervisory | SUP [X] |

Network Connectivity Status

The IP address and IP connection (DHCP or static address) are displayed:

```
LAN: 10.0.3.111
```

When no IP network is available, the **No LAN IP** message appears as shown below:

```
LAN: No LAN IP
```

Press the **MENU** button to view the next status message.

Battery and AC Power Status

```
BATTERY OK
AC POWER OK
```

Press the **MENU** button to view the next status message.

Ground Fault and Battery Charger Status

```
GROUND OK
CHARGER OK
```

Press the **MENU** button to view the next message.

7.15 Off-Normal Operation

Faults and alarms that cause off-normal operation are shown with fault messages in the LCD display. See table below for more information.

| Table 8. Faults and Alarms with Off-Normal Operation | |
|--|--|
| Off-Normal Condition Fault Message | Problem |
| AC POWER FAIL | AC power to Subscriber disconnected or below minimum voltage |
| CHARGER | Battery charger failure |
| NETCON | Subscriber NetCon value below minimum required |
| GROUND FAIL | Resistance to earth ground below limit on zone input |
| RF COMM FAIL | Failure to communicate with another unit on mesh network |
| ANNUNC FAIL | 7740 Remote Annunciator failure |
| BATTERY FAIL | Backup battery voltage below minimum |
| Alarm/Trouble Messages | |
| ZONE 2 ALARM | Example of Alarm condition; Zone 2 input |
| ZONE 7 TRBL | Example of Trouble condition; Zone 7 input |

Fault Display

Faults are shown on the LCD display on the enclosure. The general fault type (alarm, trouble, supervisory) is shown on the first line. The second line shows the specific fault. The following behavior occurs depending on whether single or multiple fault conditions exist.

- Single fault

Alarm on input 2 configured for Smoke:

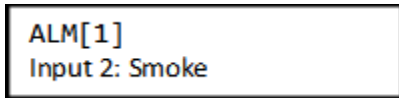

Trouble caused by battery fault:

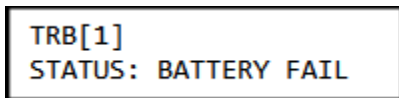

- Multiple faults

When more than one event is detected, pressing the menu button will scroll through the list. After 10 seconds of inactivity, the display reverts to showing the first event. This example shows the screens for two input alarms and one battery fault.

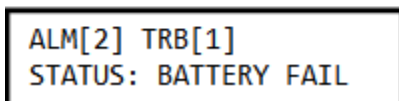
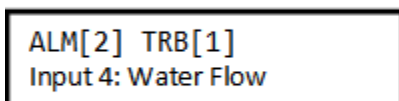
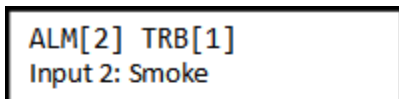

- Buzzer Silence

Press the Silence/Reset button for one second on the 7704-NAC board to silence the buzzer and NAC. The display will toggle between the event counts and SILENCED screens:

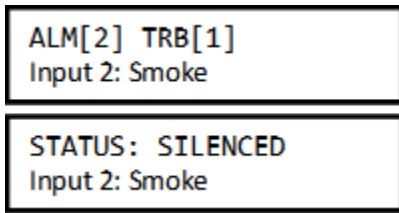

7.16 Subscriber Status Check

General

Information about the Model 7704 Subscriber is shown in the **Status** panel. The Subscriber model, firmware version, and status can be viewed by selecting the **Status** tab as shown in red below:

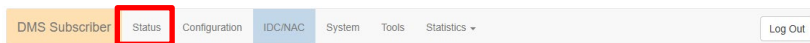

The Subscriber model number and software version are displayed:



The **Status** page shows any faults, as well as the unit (Subscriber) RF ID, Link Layer, and NetCon values:

| | |
|------------|--------|
| Status | Normal |
| Sub ID | AE54 |
| Link Layer | 1 |
| NETCON | 5 |

Faults are displayed below the status panel.

Routing Table

The Subscriber routing table is displayed in the **Routes** panel as shown below. Up to eight routes may be included:

| Routes | |
|--------|----------------------------|
| 1 | AAAA L:00 N:0 Q: Good (03) |
| 2 | B003 L:01 N:6 Q: Good (03) |

Hardware

Information about the Subscriber type, serial number, zone input configuration, alarm panel type, and IP addresses are shown in the **Hardware** panel.

- **Model type** – The Model 7704, a Fire Subscriber, displays as type **FIRE**.
- **Serial Number** – A unique serial number is assigned to each Model 7704 Subscriber at the factory.
- **Panel Interface** – None

- **Wired MAC/Wired IPv4** – The Media Access Control (MAC) address (which is the physical address) is a unique network identifier assigned to the Model 7704 Subscriber.
- **WiFi IPv4** – The address of a USB WiFi adapter (optional, supplied by others) used for wireless connection to the Subscriber during configuration is shown.

7.17 Tools

The **Tools** tab provides access to the following:

- Text Messages
- Alarm History
- RF Traffic
- IP Traffic
- RF Antenna Test
- Ping
- System Activity Log

To access these features, select the **Tools** tab as shown in red below:

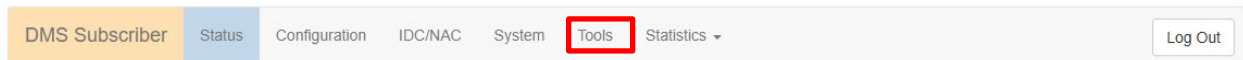

Text Message

A text message can be sent from the 7704 Subscriber to the central monitoring station. Messages from the central station can also be received.

In the **Text Messages** panel, use the message line at the bottom of the panel to enter the message. Messages have a 200-character limit. Click the **Send** button to transmit the message.

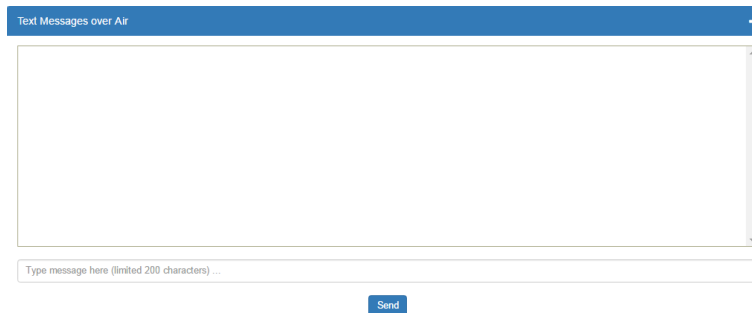

Alarm History

Messages sent from the Model 7704 Subscriber, or the alarm panel connected to the Model 7704 Subscriber, are displayed in the **Alarm History** user interface panel.

RF Traffic

Receive and transmit traffic to/from the Subscriber can be viewed using the **RF Traffic** panel. Traffic from other Subscribers can also be viewed.

IP Traffic

Messages that are sent to and from the Subscriber, and which are used for debugging purposes, are displayed in the **IP Traffic** panel.

RF Antenna Test

The RF Antenna Test turns the transceiver transmitter on for approximately 5 seconds and allows use of RF test equipment, such as a SWR meter or power meter. This function allows you to check transceiver RF power output, coaxial cable connections, antenna tuning, and other parameters.

Ping

The ping utility checks network connectivity of the Subscriber. Enter a network address on the form line and click **Submit** to verify the connection.

System Activity Log

The System Activity Log shows 7704 Subscriber information used for diagnostic purposes.

7.18 IP Configuration

The IP address of the Subscriber is set in the **Configuration** tab under the Advanced Conf. Fixed (static) or automatically assigned (DHCP) addresses may be used. DHCP addressing is the default setting.

Select the **IP Configuration** tab.

IP Address – DHCP

The Subscriber is set to Dynamic Host Configuration Protocol (DHCP) by default. An address is automatically obtained when the Subscriber is connected to a network, or if already connected, when the Subscriber is powered on.

IP Address – Static

When **Static** is selected, the form expands to show:

- IP Address
- Subnet Mask
- Gateway
- DNS Server 1
- DNS Server 2 (Optional)

7.19 Silencing/Resetting Events of Zones

If the event is set to latching, this will require the user to open the enclosure and hit the silence/reset switch located on the top right of the NAC board.

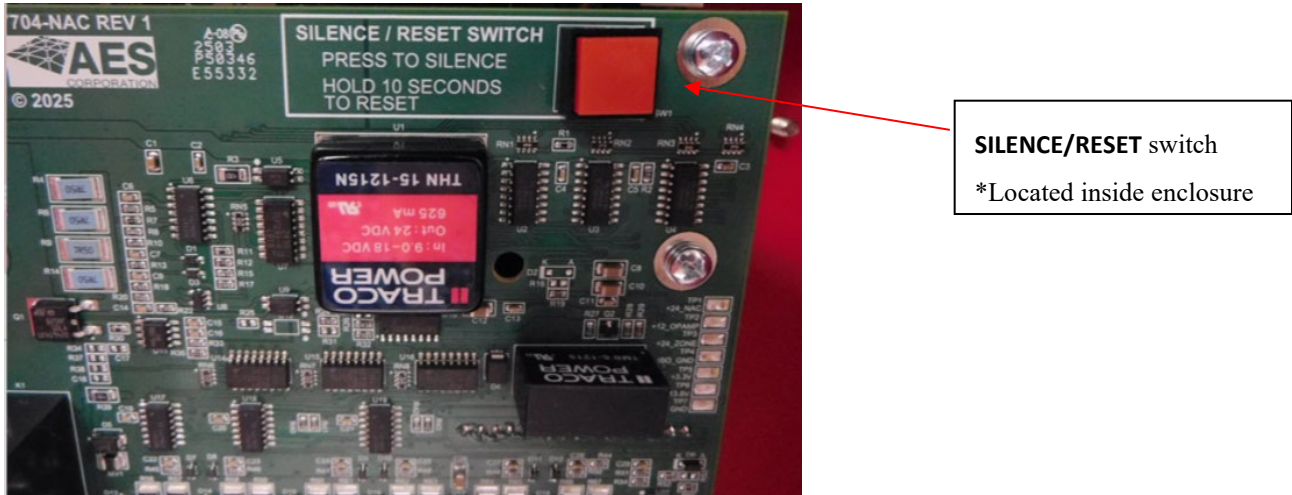

Figure 14. **SILENCE/RESET** switch inside enclosure

Option 1 Silence

Hold the red button for 1 second to silence the NAC’s devices.

Option 2 Reset

Hold the red button for 10 seconds. Upon reset, the LCD shows “System Resetting.”

“System Resetting....
Please Wait”

All latching events are restored upon reset.

8. Notification Appliance Circuits

This control panel provides a single zone capable of 0.5 amp of current. The model 7704 DMS supports class B Notification Appliance Circuits. For supported products, please see the AES NAC Compatibility document.

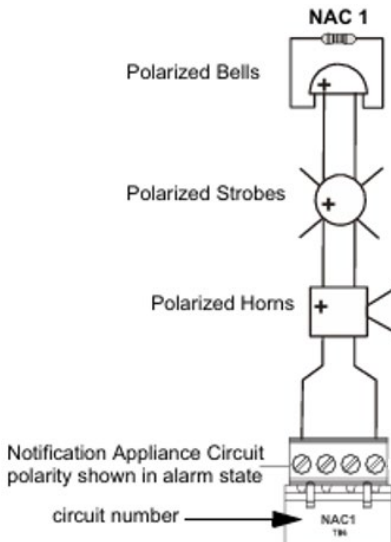

Figure 15. Class B NAC wiring

The following table lists NAC wiring requirements for the FACP:

| NAC Load (Amps) | Max. allowable total loop resistance (ohms) | CLASS-B Max. allowable wire pair length (feet) | | | |
|--------------------|---|--|-----------------|-----------------|-----------------|
| | | AWG 12 solid | AWG 14 solid | AWG 16 solid | AWG 18 solid |
| 0.25 | 14.40 | 4450 | 2797 | 1756 | 1105 |
| 0.5 | 7.20 | 2225 | 1399 | 878 | 553 |

The 7704 DMS has a maximum load of 0.5 amp.

IDC inputs have 32 mA maximum per zone

9. System Settings

The **System** tab provides access to system setting features.

9.1 Product License

Subscriber product license information is displayed in this panel.

9.2 Change Password

Change Password allows the logged-in user to set another password for the login account. If the user is logged in with a default account password, a warning about changing the password appears in red letters.

The **Login User** line displays the current user logged into the Subscriber.

To change the password:

1. Enter the existing password into the “Current Password” field.
2. Enter a new password into the “New Password” field.
3. Re-enter the new password again into the “Confirm” field. A minimum of five characters (0-9, A-Z) are required.

9.3 Add User

Add User allows you to add additional users to the system.

To add a user:

1. Enter the username into the “Username” field.
2. Enter the password into the “Password” field.
3. Re-enter the password again into the “Confirm” field.
4. When through, click the **Add User** button.

9.4 Uploading/Downloading Settings

Download Current Settings

Setting information can be downloaded from the Subscriber. Click the **Download** button.

Upload Preconfigured Settings

To upload Subscriber settings to the Model 7704, click the **Choose File** button, select the file, and click the **Upload** button.

Reset to Default Configuration

Subscriber and IDC/NAC settings can be set to factory defaults:

1. Set the **Subscriber Config** and/or **IDC/NAC Config** switch to **Yes**.
2. Click the **Reset Configuration** button.

Note: Reset with **Subscriber Config** does not change the existing Subscriber ID and cipher code programmed into the unit.

9.5 System Firmware Update

Upgrading

To upgrade the Subscriber software, click the **Choose File** button, select the upgrade file, and click the **Update** button.

Download Support Files

To download system information files, select the file type from the **Select file type** dropdown box, then click the **Download** button.

Restart System

The **Restart** button causes the Subscriber to halt communication and any system software that may be running. The system software restarts and the Subscriber resumes communication. **Note:** Remote programming is enabled for 10 minutes after a **Restart/Reset**.

10. Flexible Power Options

Refer to the diagram shown in the [Power Options](#) section on page 11 for supply and connection requirements.

- **AC Report Delay:** AC Report Delay is active when **Suppress AC Fault** is set to **NO**. The report delay is the time that must pass before the Model 7704 Subscriber sends an AC failure or AC restoral message. This feature helps prevent mesh network congestion in an area where many Subscribers have an AC power outage at the same time. Messages can be set to transmit in a staggered fashion using the **Random** time setting.

The combined AC Fail detection time delay of 100 minutes plus the random **AC Report Delay** between 0–60 minutes results in time that does not exceed 160 minutes. This is within the UL-864 requirement of reporting AC power failure within 180 minutes (3 hours) of loss.

Primary power must be lost for 100 minutes before it's reported as a failure. Primary power must be restored for at least 100 minutes to be reported as a restore. Once either is detected, a message is created by

the Subscriber to send to the central station. An AC Report Delay is selected based on both this parameter and the setting of **Suppress AC Fault Reporting**.

Available settings:

- **Random Delay** — A random time ranging from 0–60 minutes after 100 minutes of primary power loss. Enter **R** into the box to select this option.
 - **Fixed delay** — A specific time ranging from 1–60 minutes after 100 minutes of primary power loss.
 - **No Delay** — Immediate transmission after 100 minutes of primary power loss.
- **Locally Announce AC Fault**

Important! UL-864 compliant fire alarm installations require that **Locally Announce AC Fault** be set to **Yes**. See the [Programming Options \(UL Notice to Users\)](#) on page 22 for software settings permitted for the following parameter.

Set **Locally Announce AC Fault** to **Yes/No** by clicking the **Locally Announce AC Fault** switch.

- **Suppress AC Fault Reporting**

Important! UL-864 compliant fire alarm installations require that **Suppress AC Fault Reporting** be set to **No**. See the [Programming Options \(UL Notice to Users\)](#) on page 22 for software settings permitted for the following parameter.

Set **AC Fault Reporting** to **Yes/No** by clicking the **AC Fault Reporting** switch.

- **Suppress Battery Fault Reporting**

Important! UL-864 compliant fire alarm installations require that **Suppress Battery Fault Reporting** be set to **No**. See the [Programming Options \(UL Notice to Users\)](#) which starts on page 22 for software settings permitted for the following parameter.

- **Suppress Charger Fault Report**

Important! UL-864 compliant fire alarm installations require that **Suppress Charger Fault Reporting** be set to **No**. See the [Programming Options \(UL Notice to Users\)](#) which starts on page 22 for software settings permitted for the following parameter.

Set **Suppress Charger Fault Report** to **Yes/No** by clicking the **Suppress Charger Fault Report** switch.

11. Reporting

11.1 AES Mesh Network

The 7704 Subscriber can eliminate the need for POTS telephone lines by communicating with the 7705 MultiNet/8705 INCC using the AES mesh radio network.

11.2 Compatible Receiver

The 7704 Subscriber is compatible with the AES Corp. 7705 ii, and INCC 8705. The following versions or newer are required to support the DMS:

- INCC – 10.00.03.3089 or newer
- MNR – 2.0.8.7532 or newer
- NMS – 9.0.5.4739 or newer

12. Testing

Some of the tests to be performed at the installation site require a response from a person at the central station:

- Trigger alarm conditions: Confirm that the proper message is received at the Central Station.
- Cause fault conditions: Confirm that the proper message is received at the Central Station.

13. Maintenance

Once installed and normal operation is confirmed, minimal maintenance is required. Monitoring the automatic check-in test messages confirms proper RF operation. Batteries should be periodically tested to be certain they have sufficient capacity to operate the system.

14. Troubleshooting

The most common causes of an RF failure or trouble are due to:

- Antenna type
- Antenna location
- Coaxial cable
- Coaxial connectors
- Transceiver malfunction

Antennas close to metal or conductive material that block or reflect the transmitted signal are the most common problems. Try different locations for the antenna or use a remotely mounted long-range RF antenna. Try replacing the transmission components, including the coaxial cable, coaxial connectors, or antenna.

Note: No user serviceable components are located on the circuit boards. Defective circuit board units must be returned to AES. For information on returning units, see the AES Service Procedure under [Warranty](#)

15. Repair Information

Other than the backup battery, no user serviceable parts are located in the 7704 Subscriber.

16. Battery Replacement Instructions

1. Remove the positive battery lead (red) from the battery.
2. Remove the negative battery lead (black) from the battery.
3. Verify that the POWER LED indicator is NOT illuminated.
4. Remove the battery from the enclosure.
5. Discard the battery in accordance with local disposal codes.
6. Install the new battery into the enclosure.

Note: Observe $\frac{1}{4}$ in. minimum separation between non-power limited wiring and power limited wiring.

7. Connect the negative battery lead (black) to the battery.
8. Connect the positive battery lead (red) to the battery.
9. Perform Subscriber power-up and self-test procedure.

17. AES Model 7740 Annunciator Installation Instructions

17.1 Out of the Box

- One Rocker Switch Annunciator with standard ring back
- One Faceplate (red)
- One Gang Back Box (red)

Assembly hardware is included. Wall mounting hardware *is not included*

17.2 Installation Instructions

Utilize a standard single-gang mounting box. One gang space is required for each module to be installed. A standard cover plate is required to cover the assembly.

1. Label the legend sheet for the AES Model 7740.
2. Mount the box securely into the wall.
3. Connect conduit and/or pull wiring as required.
4. Remove the faceplate from the frame.

Note: Notice the routing of the Silence switch cable if applicable. In most cases, this cable need not be disconnected. Use the slack cable to allow the faceplate to be moved out of the way.

5. Terminate wires and connect the AES Model 7740 Local Annunciator, as shown in the following diagram. The 7740 is powered and supervised by the AES Model 7704 Subscriber.

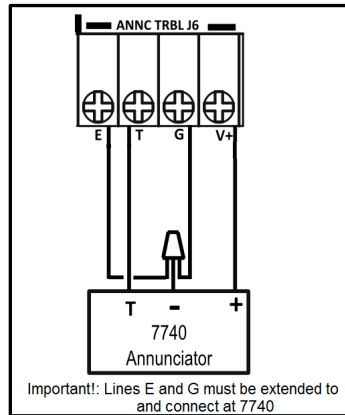

Figure 16. 7740 wiring diagram

6. Attach the frame to the box using frame screws.
7. Reinsert the faceplate into the frame.
8. Single-gang installation only.
9. Review and confirm field wiring and setup.
10. Damage and/or malfunction can result from improper wiring and/or setup.
11. Place the cover over the faceplate and secure with cover screws.
12. Power up the system and test for proper operation of all zones and functions.

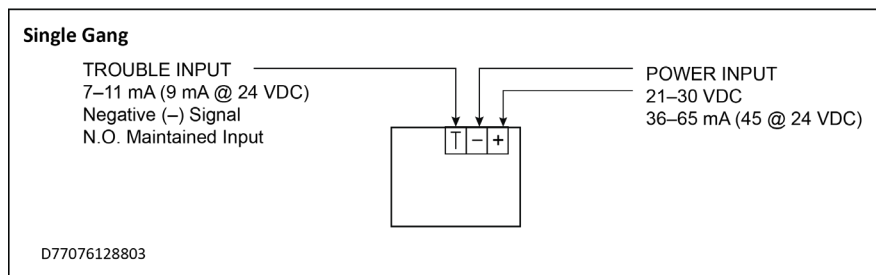

Figure 17. 7740 wire Inputs

18. AES Corp. Contact Information

AES Corporation

285 Newbury Street
 Peabody, Massachusetts 01960 USA
 Website: <http://www.aes-corp.com>
 AES corporate Phone: (800) 237-6387 (800) AES-NETS
 USA (978) 535-7310
 Fax: USA (978) 535-7313
 Email: Check Website for latest email addresses

19. Warranty

LIMITED PRODUCT WARRANTY

AES warrants to the original purchaser that the AES Subscriber Unit will be free from defects in material and workmanship under normal use and service for three (3) years from the date of original purchaser's purchase. Except as required by law, this Limited Warranty is made only to the original purchaser and may not be transferred to any third party.

This Limited Product Warranty is made in lieu of any other warranties, expressed or implied, it being understood that all other warranties, expressed or implied, inclusive of merchantability or fitness for a particular purpose, are hereby expressly excluded.

AES assumes no liability for any personal injury, property damage, consequential damages, or any other loss or damage due, among other things, to this product's failure to operate or provide adequate warning. AES's sole responsibility is to repair or replace, at AES's sole option, the AES product that is judged defected by AES during the limited warranty period under the terms of its Limited Warranty.

TECHNOLOGY LICENSE

Certain AES Products include software, protocols and other proprietary and confidential technology and trade secrets of AES which are incorporated in or provided with AES Products solely for use in conjunction with and in order to operate AES Products ("Licensed Technology"). AES grants the original purchaser a non-exclusive license to use such Licensed Technology solely in connection with the use and operation of AES Products and for no other purpose or use whatsoever. No title or ownership in or to any such Licensed Technology is conveyed by the sale or delivery of any AES Products; all such rights are retained by AES.

AES SERVICE PROCEDURE: Contact AES by Phone (978) 535-7310, Fax (978) 535-7313 or Email service@aes-corp.com, to receive a Return Material Authorization Number. Have the AES part number and serial number ready. Repack equipment in original or equivalent packaging. Inside the box, please include a contact name, telephone number, address and a brief description of the reason for return.

Ship items freight-prepaid to:

Repair Services, RMA# _____

AES Corporation,

285 Newbury Street

Peabody, MA 01960 USA

(Contact AES for Return Material Authorization number.)

Appendices

Appendix A. Supported NACs (Compatibility)

As required per UL 864, notification circuits that supply synchronized strobe power must show compatibility with certain devices. In addition, the total number of devices per circuit must be included

The table below highlights the following manufacturers. It also specifies the maximum number of devices that can be connected. Each NAC in the table reflects a configuration that uses maximum power consumption.

- Potter/Gentex
- System Sensor

The 7704 DMS has a maximum 0.5-amp output available for NAC circuits. Please refer to AES Calculator for more information.

Table A-1. NACs specific to manufacturers Potter/Gentex and System Sensor

| Model | Type | Max # of Devices Connected |
|---------------|-------------|----------------------------|
| S- 24W | Horn/Strobe | 2 |
| HS- 24W | Horn/Strobe | 2 |
| CS- 24R | Horn/Strobe | 2 |
| CHS- 24 | Horn/Strobe | 2 |
| LFHS- 24 | Horn/Strobe | 1 |
| SH | Horn/Strobe | 2 |
| S-24 | Strobe | 2 |
| CS-24 | Strobe | 2 |
| CCS-24 | Strobe | 2 |
| SPKSTR-24 WLP | Strobe | 2 |
| GES3- 24 | Strobe | 2 |
| GESA/B -24 | Strobe | 2 |
| GEH | Strobe | 5 |
| SSPK24WLP | Strobe | 1 |
| GHLF | Horn | 3 |
| LFH -24 | Horn | 1 |
| SMM24 | Bell | 9 |

Appendix B. Supported Smoke Detectors

System Sensor

(maximum number of detectors per zone: 25)

| Model | Type |
|---------|---------------|
| 2W-B | Photoelectric |
| 2WT-B | Photo/Heat |
| 1400 | Ion |
| 2400 | Photoelectric |
| 2400 TH | Photo/Therm |

Potter

(maximum number of detectors per zone: 25)

| Model | Type |
|-----------|------------|
| CPS-24 | Smoke |
| CPS-24N | Smoke |
| PS-24 | Smoke |
| PS-24N | Heat |
| IS-24 | Smoke |
| CPSD-24V | Smoke |
| CPSDH-24H | Smoke |
| PC-2P | Smoke |
| PC-2H | Smoke |
| PC-2PH | Smoke/Heat |
| PC-2PN | Smoke |

Hochiki

(maximum number of detectors per zone: 25)

| Model | Type |
|----------|-------|
| SOC-24V | Smoke |
| SOC 24VN | Heat |

Appendix C. Battery Calculator

Please visit AES-Corp.com or <https://aes-corp.com/7704-dedicated-monitoring-system-manual/> to view the most up-to-date calculator.