



Authority Having Jurisdiction (AHJ)

RESOURCE GUIDE

Purpose

The purpose of this document is to provide the local Authority Having Jurisdiction (AHJ) information regarding AES-IntelliNet® patented mesh radio technology. The AES-IntelliNet product line is based upon Radio Frequency (RF) technology. RF is used for the transport of alarm communications in accordance with NFPA 72 compliance guidelines. This document can be used to thoroughly understand the implementation of AES products for use as a **One-Way Private Radio Alarm System** as prescribed by NFPA 72 National Fire Alarm and Signaling Code. The applicable references in the NFPA 72 Code handbook for AES Corporation can be found under:

- » Year 2022 – 26.6.5.2/Technology Reference Comparison Table A.26.6.1
- » Year 2019 – 26.6.5.2/Technology Reference Comparison Table A.26.6.1
- » Year 2016 – 26.6.5.2/Technology Reference Comparison Table A.26.6.1
- » Year 2013 – 26.6.3.3.2/Technology Reference Comparison Table A.26.6.1
- » Year 2010 – 26.6.3.3.2/Technology Reference Comparison Table A.26.6.1
- » Year 2007 – 8.6.3.5/Technology Reference Comparison Table A.8.6.1
- » Year 2002 – 8.5.3.5/Technology Reference Comparison Table A.8.5.1

AES-IntelliNet Multi-Path Private Wireless Mesh Network

AES-IntelliNet is a private wireless mesh radio network made up of Subscriber units each acting as a receiver, transmitter, and repeater. Each protected premise outfitted with an AES Subscriber unit is linked to the AES-IntelliNet network by this Subscriber unit. The network allows distant Subscriber units to use one of many other Subscriber units to relay the alarm message to the network receiver hub. Signals follow the shortest route of all the available path options at that particular moment, ensuring the fastest and most reliable alarm communications possible. An explanation of some of the technical terms commonly used is provided below.

- A. Alarm Panel
- B. Subscribers
- C. IP Links or Hybrid Subscribers
- D. MultiNet Receivers

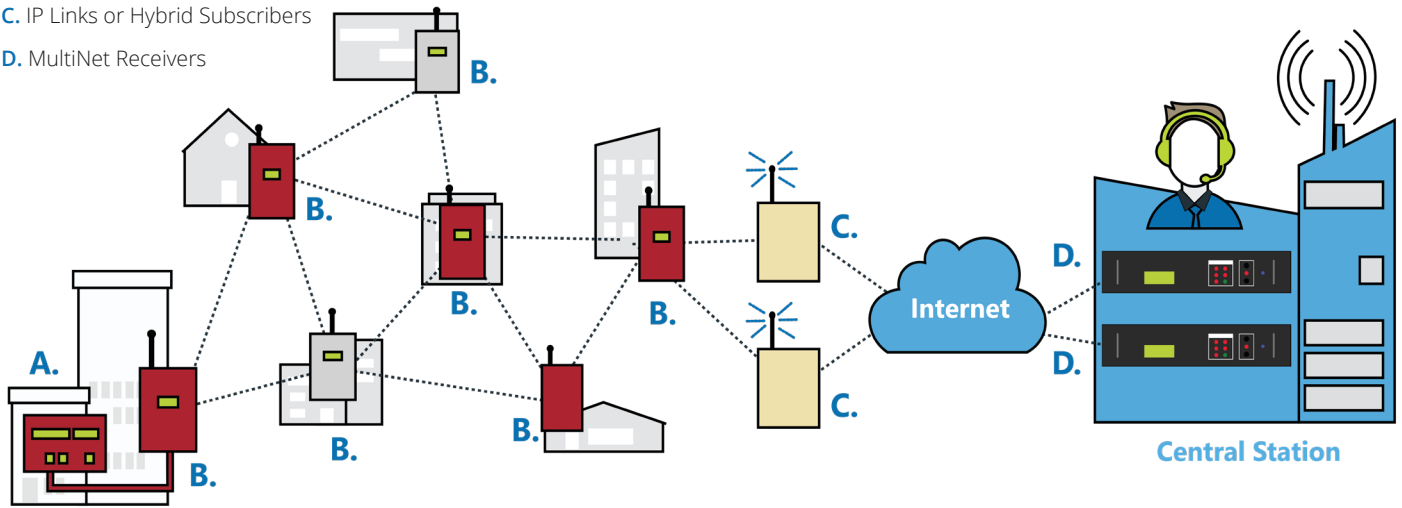

CUSTOMER LOCATION

Alarm panel & AES Subscriber sends critical event signal.

MESH RADIO TECHNOLOGY

Multi-path AES IntelliNet® Network delivers alarm signals via smart routing.

CENTRAL MONITORING STATION

Primary and secondary AES MultiNet Receivers receive transmission.



Technical Terms

Account ID

Also referred to as the Unit ID, this is a unique four character hexadecimal code used as the identifier for Subscriber units and IP Links. When communications take place on the network, the Account ID is used to identify the unit that is communicating.

Cipher Code

This is a unique four character hexadecimal code used by all Subscriber units and IP Links on a network. The Cipher Code is similar to a password or key for a network. The Cipher Code protects communications that take place over the network. Each Subscriber unit must be programmed with a Unit ID (Account Number) AND a Cipher Code in order to communicate on the network. Once programmed, the Cipher Code cannot be viewed from the Handheld Programmer; it will always appear as X's. This is done to protect the Cipher Code from illegitimate use.

AES-IntelliNet Network

The AES-IntelliNet Network is a wireless mesh radio network, defined as a Radio Alarm System (RAS) in NFPA 72 2022 3.3.222. The mesh technology is self-healing and fault-tolerant providing no less than two transmission paths for Alarm, Supervisory, and Trouble signals from the protected premise to the supervising station.

IP (Internet Protocol)

Defined as an "IP Dialer Capture Module" under NFPA 72 26.6.3 "Performance Based Technologies", AES models 7707, 7177 and 7706 have the option to transmit Alarm, Trouble, and Supervisory signals from the protected premise to the supervising station using IP (Internet Protocol).

IP Link

AES IP Links are also known as a Radio Alarm Repeater Station Receiver (RARSR), as defined in NFPA 72 3.3.238. IP Links receive Alarm, Supervisory, and Trouble signals from the mesh network and relay those signals via TCP/IP connections to the supervising station. Phone line connectivity as an optional secondary means of communications is also supported within the IP Link. Note, this is not required by NFPA or UL. To accomplish this, an active Plain Old Telephone Service (POTS) line may be connected to the Tip and Ring terminal block on the main board of the IP Link. IP Links are assigned Link Layer values of 0, as they are the termination point for RF transmissions. IP Links are also assigned a Network Connectivity (NetCon) value of 0 for the same reason. Descriptions of Link Layer and NetCon follow below.

Hybrid Subscriber

AES Hybrids are also known as a Radio Alarm Repeater Station Receiver (RARSR), as defined in NFPA 72 3.3.238 and a (RAT) as defined as in NFPA 72 3.3.241. Hybrids can be a termination point for RF transmissions as well as a communicator for a Fire Alarm Control Unit (FACU). Hybrids transmit Alarm, Supervisory, and Trouble signals from the mesh network and relay those signals via TCP/IP connections to the Radio Alarm Supervising Station Receiver (RASSR). A Hybrid becomes a (RAT) when connection to the Radio Alarm Supervising Station Receiver (RASSR) fails. When a Hybrid becomes a (RAT) signals are sent RF through the mesh network to another termination point which could be a Hybrid or IP Link.

Link Layer

The Link Layer defines the number of communication hops a Subscriber unit will take to reach an IP Link. A Link Layer of 2 indicates that there is one Subscriber unit between the reporting Subscriber unit and the IP Link. IP Links are always assigned a Link Layer of 0, as they are the last hop in the RF transmission path. The figure below depicts the Link Layer relationship:

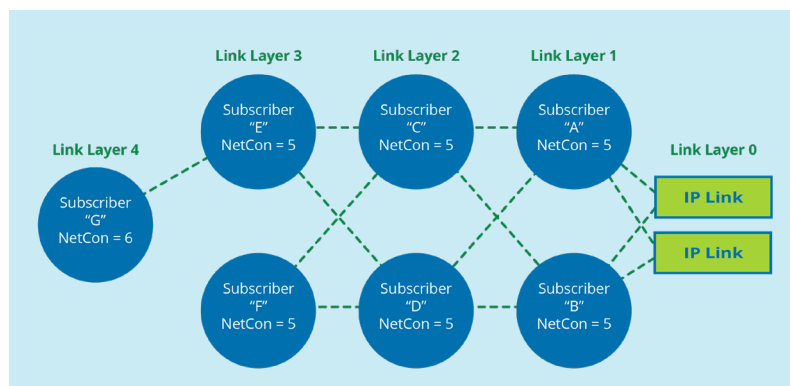

Network Connectivity (NetCon)

Network Connectivity, commonly referred to as NetCon, is a unique algorithm developed by AES Corporation as a measure of transmission paths within a mesh radio network. NetCon calculations include evaluation of signal quality and Link Layer to derive a NetCon value. As described later in this document, a NetCon value of 5 indicates 2 or more viable transmission paths thus satisfying the requirement of NFPA 72 2022 26.6.5.2.1(B) compliance. The viable transmission paths may be viewed in the Routing Table.

AES-MultiNet Receiver (MNR)

AES-MultiNet Receivers are also known as a Radio Alarm Supervising Station Receiver (RASSR) as defined in NFPA 72 2022 3.3.221. AES MultiNet Receivers are installed in pairs (Primary and Secondary) to ensure redundancy in the event of a primary failure, satisfying the requirement of NFPA 72 2022 26.6.5.2.6(B) compliance.

Radio Frequency (RF)

The transmission medium used by the mesh radio network for the transmission of signals and data is often referred to as RF. AES-IntelliNet networks operate on federally licensed, protected, and regulated spectrum within the 450 MHz and 470 MHz bands. Network owners and operators (alarm dealers, installers, or Central Monitoring Stations) are required to obtain a Federal Communications Commission (FCC) license for operation on their own assigned frequency prior to bringing a network into service. Detailed information on the licensing process is available at https://en.wikipedia.org/wiki/Broadcast_license.

Radio/Transceiver

The silver box mounted within AES Subscriber units and IP Link units is also known as the transceiver. It receives and transmits RF messages exchanged between Subscriber units and IP Links. Subscriber units are also sometimes referred to as radios.

Subscriber Unit

Subscriber units are a Radio Alarm Transmitter (RAT) as defined in NFPA 72 2022 Code 3.3.223. They may also serve as a Radio Alarm Repeater Station Receiver (RARSR) as defined in NFPA 72 3.3.220. The Subscriber unit is the final unit assembly consisting of an antenna, various electronic boards and components, and the transceiver. Subscriber units are sometimes referred to as radios, but it's important to note that they are technically the transceiver.

Routing Table

The Routing Table is a record of viable transmission paths a Subscriber unit has available to it. A Routing Table itself may contain up to a maximum of 8 viable transmission paths, although the Subscriber unit may have many more than 8 transmissions paths available. These paths, or routes, are what a Subscriber unit will use when transmitting an Alarm, Supervisory, or Trouble signal to the supervising station. The Routing Table is dynamic. As conditions change, the table is modified and other paths are entered into the list. For example, when other Subscriber units encounter troubles or as the RF climate changes, the best path is always listed first.

A good path consists of the following elements:

- » **The repeating Subscriber unit is at the same Link Layer or lower than that of the reporting Subscriber unit.**
- » **The repeating Subscriber unit has a NetCon value of 5 or 6.**
- » **The signal quality (Q) level is 02 or 03.**

The following are samples of routing tables:

4.5678,L=01,N=5,Q=03
3.7888,L=01,N=5,Q=03
2.BB12,L=00,N=0,Q=03
1.AA11,L=00,N=0,Q=03

1	9797 L:00 N:0 Q: Good (03)
2	9898 L:00 N:0 Q: Good (03)
3	7777 L:01 N:5 Q: Good (03)
4	EEEE L:01 N:5 Q: Good (02)

5	6666 L:01 N:5 Q: Good (03)
6	8888 L:01 N:5 Q: Good (03)
7	4444 L:01 N:5 Q: Good (03)
8	EEE1 L:01 N:5 Q: Good (02)

The routing table is read from the bottom to the top. Route 1 is the best possible route. The table is decoded as follows:

1 - Indicates routing table path # 1.

9797 – Account ID of the first Subscriber unit/IP Link in the pathway of the reporting Subscriber unit.

L:00 – A Link Layer of 0, this indicates that the reporting unit is to an IP Link. There are 0 hops from the reporting unit to the IP Link.

N:0 - Indicates the NetCon value unit the reporting Subscriber unit is transmitting to. IP Links are always a NetCon 0.

Q: Good (03) - This path has good signal quality.

Signal Quality

Signal Quality (Q Value) level is a measure of the RF signal. This measurement is used to evaluate the viability of communications between Subscriber units. The table below defines the signal quality values:

Q Value	Definition
01	Good RF signal strength, not heard in over 4 hours.
02	Good RF signal strength, not heard in over 2 hours.
03	Good RF signal strength, not heard recently.
81	Very weak RF signal, not heard in over 4 hours.
82	Carrier detection failure or weak RF signal, not heard in over 2 hours.
83	Carrier detection failure or weak RF signal, not heard recently.

Installation Recommendations

AES Recommended Best Practices

The following items are AES Corporation recommended Best Practices. By following these recommendations, installers will have met AES installation standards.

The AES-IntelliNet Network will ideally be built in expanding concentric rings, with the IP Links being at the center and the Subscriber units surrounding the IP Links (or Hybrid Subscribers). The following diagram depicts a well implemented AES-IntelliNet Network. In the center of the diagram, the green location pins represent the IP Links/ Hybrid Subscribers. Please note how they are positioned in the center of the rings. The red location pins represent Fire Subscriber units and the yellow location pins represent Burglary Subscriber units. The rings represent the concentric manner in which AES recommends the network be established. The green ring represents a three mile radius, this is followed by the yellow ring encompassing a six mile radius, and finally the red ring representing a nine mile radius. A network should be built within the three mile ring first, then expand to the six and nine mile rings, and grow incrementally from there. It is important to note that this diagram is only an example for reference. Actual ring radii are dependent upon geography, landscape, infrastructure, and antenna types. With those considerations taken into account, the rings may be as large as 10 miles and as small as one mile.

For an initial network build out, a minimum of 2 IP Links or Hybrid Subscribers are required. The IP Links or Hybrid Subscribers should be installed no more than 2 miles apart. If the rubber duck antenna alone is not providing NetCon5, then another antenna, either internal or external is recommended.

If external antennas are used, it is recommended that they should be physically separated by at least twenty feet (20') horizontally.

The following recommendations apply to IP Links, Hybrids, and fire/ burg Subscriber units:

- » **External antenna is mounted at least 18 inches above the roof line.**
- » **External antenna is at least 10 inches away from any parapet, wall, or obstruction.**
- » **External antenna should have 360 degree visibility.**
- » **All antennas must be plumb when mounted.**
- » **External antennas must have a lightning protector installed (preferably as close to the antenna as possible).**
- » **RG-58 cabling is no longer than twenty-five feet (25').**
- » **RG-8 cabling is no longer seventy-five feet (75').**
- » **LMR-400 (LMR-600 preferred) cabling is no longer than one-hundred twenty-five feet (125').**
- » **Service Length: A little extra coax is reasonable and desirable to allow for servicing the devices attached. Typically no more than an additional 12 inches or so should be necessary. This is needed to allow movement of the cable to enable such things as connectors to be disconnected and antenna to be installed and removed for service.**
- » **No Tight Bends: Coaxial cable does not tolerate being bent in a tight radius. Much as a solid pipe, the structure of the coax can kink if bent too much. As the cable is bent, the center conductor has the tendency to be pushed or driven toward the shield on the outside and away on the inside. Coax derives some of its characteristics from the distance between the center conductor and its shield. Tight bends can negatively affect those characteristics. Tight bending can permanently alter the coax such that it can never be corrected. 6 inch radius is the minimum recommended for the AES supplied RG-8 Coax.**



Technical Overview

Link Layer & NetCon Defined

AES Corporation utilizes a concept known as Network Connectivity (NetCon) to assess available transmission paths to Subscriber units on a network. There are three possible NetCon values that can be achieved by a Subscriber unit (see table below):

NetCon Value	Definition
7	1 weak transmission path or no available transmission paths.
6	At least 1 viable transmission path.
5	At least 2 viable transmission paths.

A NetCon value of 5 is validation that the Subscriber unit has at least two viable transmission paths as required by NFPA 72 2022 Section 26.6.5.2.1(B). The algorithm for NetCon calculation is complex and involves measures of RF signal quality as well as Link Layer (position of a communication path relative to an available IP Link). Below is a graphical representation of mesh radio network and NetCon values for Subscriber units within that network:

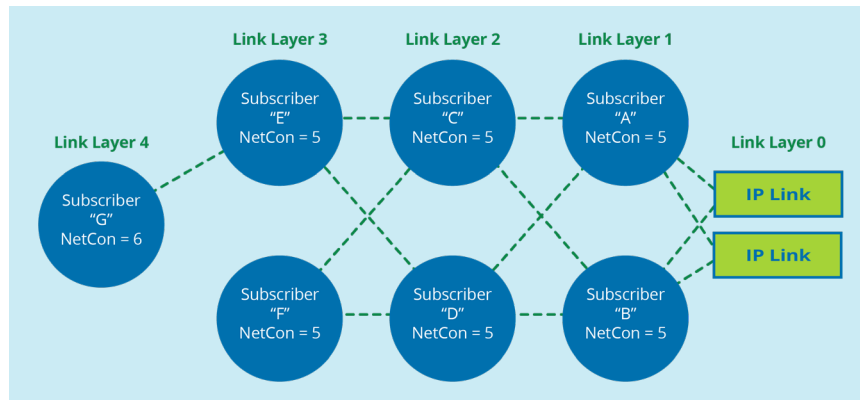

In the graphic above, you can see that the IP Link is a Link Layer of 0. This will always be the Link Layer value for an IP Link. Subscriber Unit A has a Link Layer of 1 as it is 1 'hop' from the IP Link. Subscriber Unit C is a Link Layer of 2 because it is 2 'hops' away from an IP Link. This logic continues down the chain.

Focusing on Subscriber Unit G, you will note it has a NetCon of 6 as it only has 1 forward route to the IP Link. This assumes that Subscriber Unit G cannot recognize or communicate with Subscriber Unit F. Subscriber Unit E has a NetCon level of 5 because it has two communication paths, one via Subscriber Unit C and another via Subscriber Unit D. The Link Layer of Subscriber Unit G is denoted as 4 as it requires 4 'hops' to reach the IP Link.

Subscriber units poll the mesh radio network to build Routing Tables. These Routing Tables establish the best possible route for transmissions and consists of up to 8 available routes.

When a Subscriber unit has a packet to transmit, it will reference its Routing Table and selects the route at the top of the list – this is position one (the best possible route). It then transmits the packet to that route and waits for a packet acknowledgment to be returned from that route. If it is not received, in 5 to 15 seconds, the transmission is repeated to the same route. It is repeated until it has been tried seven times. After seven attempts, the failed route is removed from the list. The list is then re-sorted and transmission continues with the new route in the number one position. This continues until the packet acknowledgment is received or the table is empty. This logic is the heart of the mesh radio network's self-healing properties.

When a Subscriber unit encounters a NetCon value of 6 or 7, it is reported to the supervising station during the Subscriber unit's daily Check-In. As described in the earlier table, a NetCon value of 7 could mean there are no available communication paths. If that is the case, then the affected Subscriber unit would have a missed Check-In – this too is reported to the supervising station.

NetCon Testing

Due to the self-healing properties of the mesh radio network, it is difficult to reproduce NetCon failures within a network. This is acknowledged in NFPA 72 2022 A.26.6.5.2 which reads in part, "...It is difficult to reliably test redundant paths on a mesh radio network without significant impact on the system and considerable efforts of time and personnel...".

Testing NetCon failures can be conducted, however there is risk to the protected premises. In the extreme case where a failure is requested in order to validate system functionality, the Subscriber unit must be taken off-line.

7707 Fire Subscriber Unit & 7177 Hybrid 2.0 Subscriber Unit

To test a NetCon failure, begin by pressing the Menu button on the front of the unit. Press the button until you reach the screen that displays Link Layer and NetCon. Alternatively you can identify the NetCon by accessing the programming interface (see Installation and Operation Manual) and navigating to the Status section. Under normal conditions the unit will report as follows:



Status	Normal
Sub ID	7707
Link Layer	1
NetCon	5

Once you have verified the NetCon value and the Routing Table, disconnect the 9 pin serial connection to the AES radio transceiver (this test is equivalent to the Subscriber unit being off-line). Depending on the size of the Routing Table, it may take up to 10 minutes for all routes to be tried and discounted as not valid. After 10 minutes, press the Menu button on the front of the unit until you reach the screen that displays Link Layer and NetCon. A NetCon failure will report as follows:



Status	1 fault
Sub ID	7707
Link Layer	255
NetCon	7

7788F Fire Subscriber Unit

To test a NetCon failure, begin by connecting the AES Handheld Programmer to the Subscriber unit. Next, press and hold the Shift key and the F4 key (Shift+F4) or d on the PC keyboard. This will provide a value for the current NetCon. Next, to display the Subscriber unit's current routing table, press just F4 key (or Ctrl+T on PC keyboard). Once you have verified the NetCon value and the Routing Table, disconnect the 9 pin serial connection to the AES radio transceiver (this test is equivalent to the Subscriber unit being off-line). Depending on the size of the Routing Table, it may take up to 10 minutes for all routes to be tried and discounted as not valid. After 10 minutes, press Shift+F4 and a NetCon of 7 will be displayed. Next press F4 and you will see a message indicated 'Not on Network', which means there are no available routes for communication. It is possible to remotely retrieve a Subscriber unit's NetCon value at the supervising station. Trained personnel will perform a "get status" on the Subscriber unit. They will be presented with the following screen:

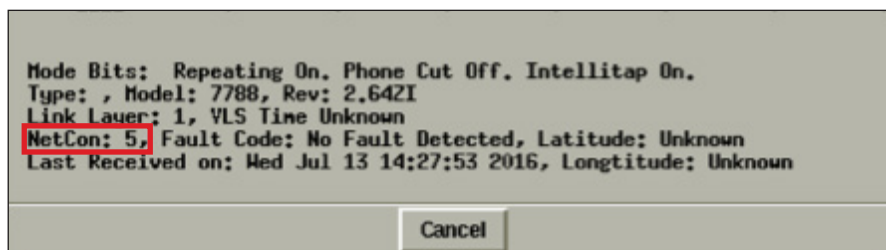

7706-ULF Integrated Fire Panel

Testing of NetCon failures can be accomplished by changing the units cipher code (see the Installation, Operation & Programming Manual) and allowing the unit to reset. After the unit has re-initialized (~3 to 5 minutes) the unit will annunciate and display "Trb-AES Comm AES PIC Trouble [1]". This identifies that the unit has lost RF communications (no viable transmission paths). By viewing the PIC status (see the Installation, Operation & Programming Manual) you can confirm the units NetCon value of 7. When testing is complete, be sure to reset the cipher code to its original value.

RF Communication Failures

NFPA 72 2022 10.14.1 requires annunciation at the protected premise within 200 seconds of an RF communications failure (trouble condition).

7707 Fire Subscriber Unit* & 7177 Hybrid 2.0 Subscriber Unit

The annunciation of an RF communications failure can be facilitated by one of the following methods:

- » **The on-board integrated annunciator. Or,**
- » **If the FACP is equipped with AUX power, the power can be connected to an AES 7740 module. The AUX power common is then connected to the J4 output of the AES Subscriber unit. This will activate the 7740 annunciator. Or,**
- » **Remote 7740 to J5 of the 7707.**

7788F Fire Subscriber Unit*

The annunciation of an RF communications failure can be facilitated by one of the following methods:

- » **The J4 output of the AES Subscriber unit is connected to the point or zone on the FACP when a FACP equipped with an annunciator is enabled for local annunciation. Or,**
- » **If the FACP is equipped with AUX power, the power can be connected to an AES 7740 module. The AUX power common is then connected to the J4 output of the AES Subscriber unit. This will activate the 7740 annunciator. Or,**
- » **Using a 7762 module combined with a 7740 will offer local annunciation using power from the AES Subscriber unit. Or,**
- » **Using a 7795 kit (7794 + 7762 + 7740) the AES Subscriber unit will offer primary communications with local annunciation.**

**The J4 output of the Subscriber unit should never be wired back into a reporting zone of the FACP. Doing so will result in a 'looping' effect that may have a harmful impact upon the mesh network. See Technical Note #003.*

Testing of RF communication failures with local annunciation can be accomplished by disconnecting the 9 pin serial connection to the AES radio transceiver. This test is equivalent to the AES Subscriber unit being off-line (there is no RF communication when the transceiver is disconnected). This is similar to pulling a phone line. There is no need to power down the Subscriber unit when performing this test – the transceiver is not in danger of being damaged as the 9 pin serial connector is the power source for the transceiver. Local annunciation will occur within 200 seconds if the RF communications is not restored.

7706-ULF Integrated Fire Monitoring System

The built-in local annunciator will satisfy the requirement of NFPA 72 2022 10.14.1. Testing of RF communication failures with local annunciation can be accomplished by changing the unit's Cipher Code and allowing the unit to reset. For detailed instructions, please refer to the product Installation, Operation & Programming Manual. After the unit has re-initialized (~3 to 5 minutes), the unit will annunciate and display "Trb-AES Comm AES PIC Trouble [1]". This identifies that the unit has lost RF communications. When testing is complete, be sure to reset the Cipher Code to its original value.

Supervising station notification of RF communication failures occurs every 24 hours via a self-test function (NFPA 72 2022 Table A.26.6.1) – this is similar to a phone line timer test. RF communications can be verified via automation reports detailing successful self-test completions (CID E602). Automation will provide notification when expected self-tests are missed (i.e., RF communication failures). The steps to reproduce an RF communications failure are similar to the steps mentioned above in the NetCon section and carry the same level of risk to the protected premise.

Battery Requirements

7707 Fire Subscriber Unit

The following table details AES battery recommendations for the 7707 Fire Subscriber unit, along with the accompanying add-on accessory boards. The requirement of NFPA 72 2022 10.6.7.2.1 will be satisfied when using these recommendations and when the batteries are properly maintained and serviced.

System Configuration Description	Battery Size
7707, 7711 (8 zone input card)	6 Ah
7707, 7712 (8 zone input card - 4 ea. EOL and 4 ea. reverse polarity)	6 Ah
7707, 7794A (IntelliPro Fire Module), 7711 (8 zone input card)	12 Ah
7707, 7794A (IntelliPro Fire Module), 7712 (8 zone input card - 4 ea. EOL and 4 ea. reverse polarity)	12 Ah
7707, 7794A (IntelliPro Fire Module)	12 Ah

Below are the Current Consumptions for Backup Battery Power of the 7707:

- » Standby = .190A
- » Transmit = .752A
- » Optional 7794A = .165A, Standby and Alarm

7788F Fire Subscriber Unit

The following table details AES battery recommendations for fire Subscriber units, along with the accompanying add-on accessory boards. The requirement of NFPA 72 2022 10.6.7.2.1 will be satisfied when using these recommendations and when the batteries are properly maintained and serviced.

System Configuration Description	Battery Size
7788F (8 zone input card)	5 Ah
7788F + 7794 (8 zone input card with IntelliPro)	10 Ah
7788F + 7794 + 7762 + 7740 (8 zone input card with IntelliPro, hardware supervisory module, and local annunciator)	10 Ah
7788F + 7762 + 7740 (8 zone input card with hardware supervisory module and local annunciator)	10 Ah

Below are the Current Consumptions for Backup Battery Power of the 7788F:

- » Standby = .149A
- » Transmit = .728A
- » Optional 7794 = .160A, Standby and Alarm
- » Optional 7762 = .015A

7170 Remote IP Link Receiver

An IP Link requires a 12v 10Ah battery as a secondary power source to ensure 24-hour operation in the event of a primary power loss. The requirement of NFPA 72 2022 10.6.7.2.1 will be satisfied when using a battery of this size and when the battery is properly maintained and serviced. The IP Link has a current draw of 370mA standby and 900mA transmit (alarm).

Battery Requirements

7177 Hybrid 2.0 Fire Subscriber

The battery size requirement for all 7177 Hybrid configurations is a 12Ah battery which satisfies the requirement for 24-hour backup.

Below are the Current Consumptions for Backup Battery Power of the 7177:

- » Standby = .355A
- » Transmit = .786A

7706-ULF Integrated Fire Monitoring System

Before selecting the battery, it is important to determine the minimum size batteries for standby and alarm times desired for each application. If the wrong batteries are installed in a specific application or incorrect current draw is used, the proper standby and minimum alarm time will not be present.

The battery circuit is rated for 8 to 18 AH batteries and will operate the panel alarm for at least 24 hours and 5 minutes. The cabinet will house up to two (2) 8 AH or two (2) 18 AH batteries.

Please use the worksheet on AES Corporation's official website to calculate the battery size and current draw required for each application:

https://aes-corp.com/wp-content/uploads/2020/11/BatteryCalc_7706-ULF.xls

The following are the current draw specifications for the 7706-ULF per the related AES installation and operation manuals.

- » Mainboard (PFC-6006): 105mA standby, 160mA transmit (alarm)
- » Subscriber unit (7788F, 7764, & 7085UE5): 200mA standby/transmit (alarm)
- » LCD Remote RA-6075: 20mA standby, 25mA transmit (alarm)

NFPA 72 2022 Table A.26.6.1 *Communications Methods for Supervising Stations*

**Note: Performance Based Technologies should be referenced only when AES Subscribers (communicators) use IP over RF.*

Criteria	One-Way Private Radio Alarm Systems 26.6.5.2	Performance Based Technologies 26.6.3
Federal Communications Commission (FCC) approval when applicable.	Yes	Yes
Conform to NFPA 70	Yes	Yes
Monitoring for integrity of the transmission and communications channel.	Test signal from every transmitter once every 24 hours.	Monitor for integrity.
Annunciate, at the supervising station, the degradation and restoration of the transmission or communications channel.	Only monitor the quality of signal received and indicate if the signal falls below minimum signal quality specified in Code.	Within 60 minutes for a single communication path and within 6 hours for multiple communication paths.
Redundant communication path where a portion of the transmission or communications channel cannot be monitored for integrity.	Minimum of two independent RF paths must be simultaneously employed.	
Interval testing of the backup path(s).	No requirement, because the quality of the signal is continuously monitored.	
Annunciation of communication failure or ability to communicate at the protected premises.	Monitor the interconnection of the premises unit elements of transmitting equipment, and indicate a failure at the premises or transmit a trouble signal to the supervising station.	Systems where the transmitter at the local premises unit detects a communication failure, the premises unit will annunciate the failure within 200 seconds of the failure.
Time to restore signal receiving, processing, display, and recording equipment.	Where duplicate equipment not provided, spare hardware required so a repair can be effected within 30 minutes.	Where duplicate equipment not provided, spare hardware required so a repair can be effected within 30 minutes.
Loading capacities for system units and transmission and communications channels.	512 buildings and premises on a system unit with no backup. Unlimited if you can switch to a backup in 30 seconds.	512 independent alarm systems on a system unit with no backup. Unlimited if you can switch to a backup in 30 seconds.
End-to-end communication time for an alarm.	90% probability to receive an alarm in 90 seconds, 99% probability in 180 seconds, 99.999% probability in 450 seconds.	90 seconds from initiation of alarm until displayed to the operator and recorded on a medium from which the information can be retrieved.
Record and display rate of subsequent alarms at supervising station.	When any number of subsequent alarms come in, record at a rate not slower than one every additional 10 seconds.	Not slower than one every 10 additional seconds.
Signal error detection and correction.	Not addressed	Signal repetition, parity check, or some equivalent means of error detection and correction must be used.
Path sequence priority.	Not addressed	No need for prioritization of paths. The requirement is that both paths are equivalent.
Carrier diversity	Not addressed	

NFPA 72 2022 Table A.26.6.1 *Continued*

Note: Performance Based Technologies should be referenced only when AES Subscribers (communicators) use IP over RF.

Criteria	One-Way Private Radio Alarm Systems 26.6.5.2	Performance Based Technologies 26.6.3
Throughput probability	90% probability to receive an alarm in 90 seconds, 99% probability in 180 seconds, 99.999% probability in 450 seconds.	
Unique premises identifier	Yes	If a transmitter shares a transmission or communication channel with other transmitters, it must have a unique transmitter identifier.
Unique flaws	None addressed	From time to time, unique flaws might be present in a communication system. Requirements must be written for unique flaws.
Signal priority	Chapter 10 on fundamentals requires that alarm signals take priority over supervisory signals unless there is sufficient repetition of the alarm signal to prevent the loss of an alarm signal.	If the communication method is shared with any other communication method, prioritizing alarm signals should be considered.
Sharing communications equipment on premises.	Not addressed	If the transmitter is sharing on-premises communications equipment, the shared equipment must be listed for the purpose (otherwise the transmitter must be installed ahead of the unlisted equipment).

Field Inspection Checklist (RF Communications)

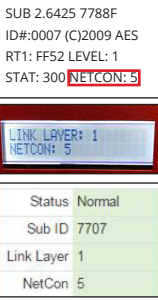
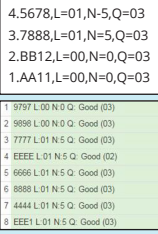
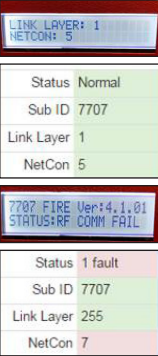
Test	Description	Applicable Product	NFPA 72 2022	Result (Pass/ Fail)	Image/ Example	Test Instructions
Is the unit connected to a circuit that is dedicated to the fire alarm system only?	NFPA requires the primary power supply be under 'no other load'.	All	10.6.5.1.2			Visually inspect.
Is the AC/DC transformer mounted within an approved enclosure?	Required for UL compliance when not connected to a UPS.	All				Visually inspect.
Is the AC/DC transformer securely fastened with a screw?	Required for UL compliance when not connected to a UPS.	All				Visually inspect.
Is the proper battery in place?	NFPA requirements for power supply capacity	All	10.6.7.2			Visually inspect, review battery calculations.
If an external antenna is in use, is a lightning protector connected and run to ground?	NFPA requires external antennas be protected to minimize damage from static discharge and lightning.	All	26.6.2.3.2			Visually inspect.
Does the Subscriber unit have a NetCon value of 5?	NFPA requires a minimum of 2 transmission paths.	7788F 7707 7177	26.6.5.2.1(B)		 <p>SUB 2.6425 7788F ID#:0007 (C)2009 AES RT1: FF52 LEVEL: 1 STAT: 300 NETCON: 5</p> <p>LINK LAYER: 1 NETCON: 5</p> <p>Status Normal Sub ID 7707 Link Layer 1 NetCon 5</p>	7788F: Connect the AES handheld programmer and press Shift+F4 – this will provide a value for the current NetCon. 7707: Press the Menu button on the front of the unit until the Link Layer and NetCon screen is displayed. Verify the NetCon reading is a 5. This information may also be viewed via the graphical user interface.
Does the routing table contain at least 2 transmission paths?	NFPA requires a minimum of 2 transmission path.	7788F 7707 7177	26.6.5.2.1(B)		 <p>4.5678,L=01,N=5,Q=03 3.7888,L=01,N=5,Q=03 2.BB12,L=00,N=0,Q=03 1.AA11,L=00,N=0,Q=03</p> <p>1 9797 L 00 N 0 Q Good (03) 2 9898 L 00 N 0 Q Good (03) 3 7777 L 01 N 5 Q Good (03) 4 EEEE L 01 N 5 Q Good (02) 5 9566 L 01 N 5 Q Good (03) 6 8888 L 01 N 5 Q Good (03) 7 4444 L 01 N 5 Q Good (03) 8 EEEE L 01 N 5 Q Good (03)</p>	7788F: Connect the AES handheld programmer and press F4 - this will detail the Subscriber unit's current routing table. 7707: Press the Menu button on the front of the unit until the Routing Table is displayed. This information may also be viewed via the graphical user interface.
Successfully complete an antenna cut test (RF Failure).	NFPA requires reporting RF failure and antenna supervision.	7707 7177	26.6.5.2.3(A) & (B)		 <p>LINK LAYER: 1 NETCON: 5</p> <p>Status Normal Sub ID 7707 Link Layer 1 NetCon 5</p> <p>7707 FIRE Ver:4.1.01 STATUS:RF COMM FAIL</p> <p>Status 1 fault Sub ID 7707 Link Layer 255 NetCon 7</p>	To test an antenna cut, begin by pressing the Menu button on the front of the unit. Press the button until you reach the screen that displays Link Layer & NetCon. Alternatively you can identify the NetCon by accessing the programming interface (see Installation & Operation Manual) & navigating to the Status section. Once you have verified the NetCon value and the Routing Table, disconnect the 9 pin serial connection to the AES radio transceiver (this test is equivalent to the Subscriber unit being offline). Depending on the size of the Routing Table, it may take up to 10 minutes for all routes to be tried and discounted as not valid. After 10 minutes, press the Menu button on the front of the unit until you reach the screen that displays Link Layer & NetCon.

Field Inspection Checklist (RF Communications)

Test	Description	Applicable Product	NFPA 72 2022	Result (Pass/ Fail)	Image/ Example	Test Instructions
Successfully complete an antenna cut test (RF Failure).	NFPA requires reporting RF failure and antenna supervision.	7788F	26.6.5.2.3(A) & (B)			To test an antenna cut, begin by disconnecting the 9 pin serial connection to the AES radio transceiver (this test is equivalent to the Subscriber unit being offline), connect the AES handheld programmer and press Shift+F4 – this will provide a value for the current NetCon. Next, press F4 – this will detail the Subscriber unit's current routing table. Depending on the size of the routing table it may take up to 10 minutes for all routes to be tried and discounted as not valid. After 10 minutes, press Shift+F4 and a NetCon of 7 will be displayed. Next press F4 and you will see a message indicated 'Not on Network', which means there are no available routes for communication.
Does the panel unit have a NetCon value of 5?	NFPA requires a minimum of 2 transmission paths.	7706-ULF	26.6.5.2.1(B)			Using the keypad, press 5 then enter. Enter the code of 1111 then enter. Press 8 then enter. Press 1 to view status where the NetCon value will be displayed.
Does the routing table contain at least 2 transmission paths?	NFPA requires a minimum of 2 transmission paths.	7706-ULF	26.6.5.2.1(B)			Using the keypad, press 5 then enter. Enter the code of 1111 then enter. Press 8 then enter. Press 2 to view the available routes. Use the arrow keys to scroll.
Successfully complete an antenna cut test (RF Failure)	NFPA requires reporting RF failure and antenna supervision.	7706-ULF	26.6.5.2.3(A) & (B)			To test an antenna cut, follow the steps detailed in the 7706-ULF Installation, Operation & Programming Manual for changing the Cipher Code and reviewing the Routing Table. Reporting
Reporting of Alarm, Supervisory, and Trouble signals.	NFPA requires reporting of Alarm, Supervisory, and Trouble signals.	All	10.8 to 10.11, 10.13 to 10.14, 10.17, 26.2.1.2, 26.2.1.3, 26.2.3, 26.2.4			Trip the related zones on the FACP, verify receipt of signals at the supervising station.
Reporting of AC failure	NFPA requires reporting for the loss of AC power.	All	26.6.5.2.3(A)			Disconnect AC power from the Subscriber unit. Reporting will occur within 100 to 160 minutes per NFPA.

Field Inspection Checklist (IP Communications)

Test	Description	Applicable Product	NFPA 72 2022	Result (Pass/ Fail)	Image/ Example	Test Instructions
Reporting of Alarm, Supervisory, and Trouble signals.	NFPA requires reporting of Alarm, Supervisory, and Trouble signals.	7707 7177	10.8 to 10.11, 10.13 to 10.14, 10.17, 26.2.1.2, 26.2.1.3, 26.2.3, 26.2.4			Trip the related zones on the FACP, verify receipt of signals at the supervising station.
Reporting of AC failure.	NFPA requires reporting for the loss of AC power.	7707 7177	26.6.5.2.3(A)			Disconnect AC power from the Subscriber unit. Reporting will occur within 100 to 160 minutes per NFPA.
Annunciate, at the supervising station, the degradation and restoration of transmission or communications channel.	NFPA requires the loss of a signal path be annunciated within 60 minutes.	7707 7177	26.6.3.2 26.6.3.3			Disconnect the IP connection from the unit. Verify the Central Station receives notification if a missed check-in from the Account ID associated with the unit.
Annunciation of communications failure or the ability to communicate to the protected premise.	NFPA requires communications failures be annunciated at the protected premise within 200 seconds.	7707 7177	A.26.6.1			Disconnect the IP connection from the unit. Verify the local annunciator sounds within 200 seconds.
90 second alarm reporting time.	NFPA requires alarms be communicated to the supervising station within 90 seconds of initiation.	7707 7177	26.6.3.8			Trip the related zones on the FACP, verify receipt of signals at the supervising station within 90 seconds.
Is the proper battery in place?	NFPA requirements for power supply capacity.	7707 7177	10.6.7.2 26.6.3.13			Visually inspect, review battery calculations. Field Inspection Checklist (IP Communications)

NFPA 72 2019/ 2022 Code Conformance

Code Section	Requirement Satisfied
10.6 Power Supplies	Installers are responsible for adhering to this section of code to ensure the requirements are satisfied.
10.6.7.1 Secondary Power Operation	When properly sized batteries are installed, the performance of the system will not be affected when operating on secondary power.
10.6.7.2.11 The secondary power supply for communications equipment at the protected premise that is used to transmit signals to a supervising station shall have sufficient capacity to operate the system under quiescent load (system operating in a non-alarm condition) for a minimum of 24 hours.	When installed in accordance to the AES installation manual, AES fire products conform to and satisfy the capacity requirements for secondary power supplies as specified in this code section.
10.6.9.1.1 Failure of either the primary or secondary power supply shall result in a trouble signal in accordance with Section 10.14	Power supplies (primary and secondary) are supervised within the AES products.
10.8 Detection and Signaling of Conditions	AES fire products satisfy the applicable requirements of this section.
10.9 Responses	AES fire products satisfy the applicable requirements of this section.
10.10 Distinctive Signals	AES fire products satisfy the applicable requirements of this section.
10.11 Alarm Signals	AES fire products satisfy the applicable requirements of this section.
10.13 Supervisory Signals	AES fire products satisfy the applicable requirements of this section.
10.14 Trouble Signals	AES fire products satisfy the applicable requirements of this section.
10.17 Annunciation and Annunciation Zoning	AES fire products satisfy the applicable requirements of this section.
26.2.3 Alarm Signal Content	AES fire products satisfy the applicable requirements of this section.
26.2.4 Restoral Signals	AES fire products satisfy the applicable requirements of this section.
Table 26.6.1 Communications Methods for Supervising Stations	AES fire products satisfy the requirements associated with One-Way Private Radio Alarms Systems as detailed in the table.
26.6.2.3.1(1) & (2) Alarm system equipment and installations shall comply with the Federal Communications Commission (FCC) rules and regulations, as applicable, concerning the following: (1) Electromagnetic radiation and (2) Use of radio frequencies	AES fire products comply with this section, radio equipment is certified with the FCC.
26.6.2.3.2 Equipment shall be installed in compliance with NFPA 70	Installers are responsible for adhering to this section of code to ensure the requirements are satisfied.
26.6.2.3.3 The external antennas of all radio transmitting and receiving equipment shall be protected in order to minimize the possibility of damage by static discharge or lightning	Installers are responsible for adhering to this section of code to ensure the requirements are satisfied.
26.6.5.2 One-Way Private Radio Alarm Systems	AES fire products satisfy the requirements of this section.
26.6.5.2.8 Wireless Mesh Networks (WMS). A wireless mesh network utilizing listed components satisfies the requirements of 26.6.5.2.	AES fire products satisfy the requirements of this section.
26.6.3 Performance-Based Technologies	The AES 7707 Fire Subscriber satisfies the requirements of this section.
2022 Code Update: 26.6.4.1.1 The requirements of 26.6.4.2 shall not apply when a DACT is used as a signaling interface from a fire alarm control unit to another listed communications means.	AES fire products apply to the condition of this section.

ABOUT AES CORPORATION

AES Corporation is the leading manufacturer of code compliant wireless alarm communication products and solutions serving commercial security markets and government agencies worldwide. **AES-IntelliNet®** patented technology will never sunset compared to obsoleting technologies such as cellular and traditional phone lines. AES private mesh radio networks are owner operated and controlled, providing infinite scalability and superior reliability with the fastest transmission speed available. Over a half million AES Smart Subscribers are installed worldwide. AES is the clear choice for life safety and security, protecting people and property for over 40 years. For more information, please visit aes-corp.com.

Contact us at **(800) 237-6387**, or info@aes-corp.com.

AES Corporation | 285 Newbury Street | Peabody, MA 01960 United States

©2023 AES Corporation | AES-IntelliNet® is a registered trademark of AES Corporation